

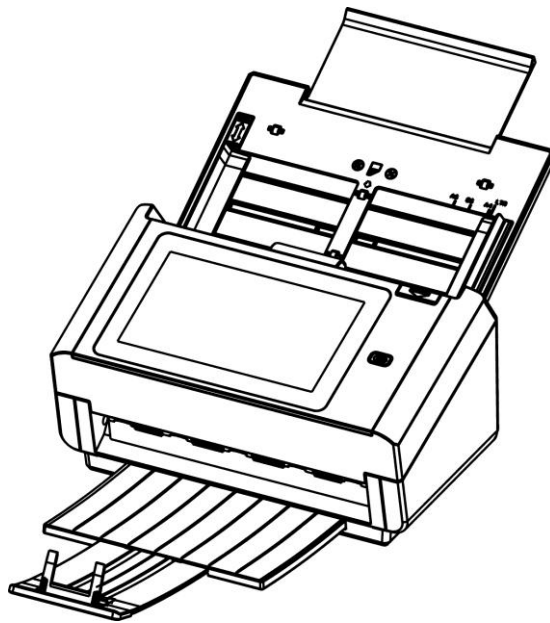

Network Scanner

User's Manual



Regulatory model: FL-1801H

Avision Inc.

Copyrights and Trademarks

Ethernet is a registered trademark of Xerox Corporation.

Microsoft, Windows 7, Windows 8, and Windows 10 are registered trademarks of Microsoft Corporation in the United States and/or other countries.

Other product names used herein are for identification purposes only and may be trademarks of their respective companies. We disclaim any and all rights to those marks.

Warranty

The information contained in this document(s) is subject to change without notice. The manufacturer makes no warranty of any kind with regard to this material, including, but not limited to, the implied warranties of fitness for a particular purpose. The manufacturer shall not be liable for errors contained herein or for incidental or consequential damages in connection with the furnishing, performance, or use of this material.

Safety Information

When using this equipment, the following safety precautions should always be followed.

Safety During Operation

In this manual, the following important symbols are used:

 **WARNING:**

Indicates potentially hazardous situations, which if instructions are not followed, could result in death or serious injury.

 **CAUTION:**

Indicates a potentially hazardous situation which, if instructions are not followed, may result in minor or moderate injury or damage to property.

Important:

Indicates operational requirements and restrictions. Please read and follow these instructions to ensure a proper operation and to avoid damage to the machine.

Note:

Indicates further explanation or clarification. Reading this is highly recommended.

 **WARNING:**

To avoid hazardous electric shock or fire, do not remove any covers or screws other than those specified in this manual.

 **CAUTION:**

- ✓ To reduce the risk of fire, use only no.26AWG or larger telecommunication line cord.
- ✓ Disconnect the power plug by pulling the plug, not the cable.
- ✓ Do not touch the metal fingers of the ADF pad module. The edges are sharp and touching them may result in injury.

Precautions

- Do not install the equipment near heating or air conditioning units.
- Do not install the equipment in a humid or dusty place.
- Place the equipment securely on an even, flat surface. Tilted or uneven surfaces may cause mechanical or paper-feeding problems.
- Retain the box and packing materials for shipping purposes.

Federal Communications Commission (FCC) compliance information statement

Part 15

This equipment has been tested and found to comply with the limits for a Class B digital device, pursuant to Part 15 of the FCC Rules. These limits are designed to provide reasonable protection against harmful interference in a residential installation. This equipment generates, uses and can radiate radio frequency energy and, if not installed and used in accordance with the instructions, may cause harmful interference to radio communications.

However, there is no guarantee that interference will not occur in a particular installation. If this equipment does cause harmful interference to radio or television reception, which can be determined by turning the equipment off and on, the user is encouraged to try to correct the interference by one of the following measures:

- Reorient or relocate the receiving antenna.
- Increase the separation between the equipment and receiver.
- Connect the equipment into an outlet on a circuit different from that to which the receiver is connected.
- Consult the dealer or an experienced radio/TV technician for help.

This device complies with Part 15 of the FCC Rules. Operation is subject to the following two conditions: (1) This device may not cause harmful interference, and (2) this device must accept any interference received, including interference that may cause undesired operation.



European Union Regulatory Notice

Products bearing the CE marking comply with the following EU Directives:

- Low Voltage Directive 2014/35/EC
- EMC Directive 2014/30/EC
- Restriction of the use of certain hazardous substances (RoHS) Directive 2011/65/EU
- RED (Radio Equipment Directive) (2014/53/EC)

CE compliance of this product is valid if powered with the correct CE-marked AC adapter provide by Avison.

This product satisfies the Class B limits of EN55032, EN55035, and safety requirements of EN62368-1.

*This machine is certified as Class 1 LED product.



*Note the operating temperature for the battery is from -20° to 60° C. And the operating temperature for the product is from 10° to 35°C.

If the operating temperature for the battery is outside the range of -20°~60° C, it may cause cracking, rupturing, bursting, emission of flame or expulsion of molten metal to the outside of the equipment enclosure.

Product Safety Guide

Please clearly read all these instructions, and follow all instructions and warnings before installing and using the device.

The following indications are used in this document to obviate any chance of accident or damage to you and/or the device.

 WARNING	Indicates potentially hazardous situations, which if instructions are not followed, could result in death or serious injury.
 CAUTION	Indicates a potentially hazardous situation which, if instructions are not followed, may result in minor or moderate injury or damage to property.

WARNING

- Use only the AC power adapter that came with your device. Using any other AC power adapter could cause fire, electrical shock, or injury.
- Use only the AC power cord and USB cable that came with your device and avoid abrasions, cuts, fraying, crimping, and kinking. Using any other AC power cord and USB cable could cause fire, electrical shock, or injury.
- Do not place objects on top of the AC power cord, and do not allow the AC power adapter or the AC power cord to be stepped on or run over.
- Place the device and its AC power adapter near an electrical outlet where the AC power adapter can easily be unplugged.
- If you use an extension cord with the device, make sure that the total ampere rating of the devices plugged into the extension cord does not exceed the cord's ampere rating.
- Place the device close enough to the computer so that the interface cable can easily reach between the device and the computer.
- Do not place or store the device or its AC power adapter:
 - Outdoors
 - Near excessive dirt or dust, water, or heat sources
 - In locations subject to shocks, vibrations, high temperature or humidity, direct sunlight, strong light sources, or rapid changes in temperature or humidity
- Do not use the device with wet hands.
- Never disassemble, modify, or attempt to repair the AC power adapter, device, or device option by yourself, except as specifically explained in the device's documentation. This could cause fire, electrical shock, or injury.
- Do not insert objects into any opening, as they may touch dangerous voltage points or short-out components. Beware of electrical shock hazards.
- Unplug the device and the AC power adapter, and refer servicing to qualified service personnel under the following conditions:
 - The AC power adapter or plug is damaged.
 - Liquid has entered the device or the AC power adapter.
 - Object has entered the device or the AC power adapter.
 - The device or the AC power adapter has been dropped, or the case has been damaged.
 - The device or the AC power adapter does not operate normally (i.e. appearance of smoke, strange smell, odd noise, etc.), or exhibits a distinct change in performance
- Unplug the device and the AC power adapter before cleaning.

 **CAUTION:**

- Do not attempt to operate the product in temperature outside the range of -20°~60° C. If so, this may cause cracking, rupturing, bursting, emission of flame or expulsion of molten metal to the outside of the equipment enclosure.
Note the the operating temperature for the battery is from -20° to 60° C and the operating temperature for the product is from 10° to 35° C.
- Do not locate the device on ractory or aslope tables. Do not locate the device on unstable surface. The device may fall down and this may result in injury.
- Do not place heavy objects on the unit. It may cause unbalance and the device may fall down. This may result in injury.
- Store the AC Power cord/USB cable bundled out of the reach of children to avoid the risk of injury.
- Keep plastic bags bundled out of the reach of children to avoid the danger of suffocation.
- If you are not going to use the device for a long period, unplug the AC power adapter from the electrical outlet.

Disposal of Waste Equipment by Users in Private Union



This symbol on the product or on its packaging indicates that the product can not be disposed of with your other household waste. Instead it should be sent to appropriate facilities for recovery and recycling in an effort to protect human health and the environment. Fore more information about where you can drop off your waste equipment for recycling, please contact your local city office, your household waste disposal service or the shop where you purchased the product.



As an ENERGY STAR® Partner, Avison Inc. has determined that this product meets the ENERGY STAR guidelines for energy efficiency.

System Requirements

CPU: Intel® Core™ 2 Duo or higher

Memory: 32 bit: 2 GB
64 bit: 4 GB

Optical Drive: DVD-ROM Drive

USB Port: USB port 3.1 Gen 1 (compatible with USB 2.0)

Compatible Operating System: Windows 10 (32 bits/64 bits), Windows 8 (32 bits/64 bits), Windows 7

System:

Contents

1	Getting Started	1
	Introduction	1
	Various Scan to Destinations.....	1
	Package Items	3
	External View	4
	The Front View.....	4
	The Rear View.....	5
	The Side View	6
	Removable Parts.....	6
	Pre-installation Information.....	7
	Preinstallation	7
	Frequently Used Buttons on the Touch Screen	9
2	Installing Your Machine.....	10
	Minimum Configuration Requirements	10
	Installing the ADF Paper Tray	11
	Connecting the Cables	12
	Connecting the Ethernet Cable.....	12
	Connecting the Power and Turning on the Machine	12
	Turning Off the Machine.....	13
	Selecting Your Language	14
	Setting Date and Time	15
	Specifying the Product's TCP/IP Address	16
	Specifying the Product's Mail Server	17
	Creating Your Address Book	18
	Creating Your Filing Profiles.....	19
	Installing and Launching a Plug-In App (Optional)	21
3	Operation	27
	Document Loading Tips	27
	Loading Document(s) in the ADF.....	28
	Scanning a Stack of Document with Various Sizes and Weights	30
	Scanning and Sending Your Document to E-mail Addresses	32
	Basic Operation.....	32
	Advanced Operation.....	34
	Settings for Various Mail Servers.....	41
	Settings on the Machine's Webpage	45
	How to import e-mail address from a LDAP Server	48
	Sending Your Document to a Network Folder, a USB Flash Drive or a Public Folder	52
	Basic Operation.....	52
	Advanced Operation.....	54
	How to Send Your Image to SharePoint.....	56
	Sending Your Document to Clouds	58
	Basic Operation.....	58
	Advanced Operation.....	60
	How to Send Your Image to SharePointOnline.....	62

	Creating a Shortcut Button	64
	Using the Shortcut Buttons	66
	Scanning and Broadcasting Your Images	67
	Basic Operation	67
	Advanced Operation	70
4	Setting Up and Managing Destinations	73
	Setting Up Your E-mail Address Book	73
	Adding a new E-mail Address	73
	Editing a Current E-mail Address	74
	Deleting a Current E-mail Address	74
	Adding a new E-mail Group	75
	Editing a Current E-mail Group	76
	Deleting a Current E-mail Group	76
	Setting Up Your Filing Profiles	77
	Adding a new Filing Profiles	77
	Editing a Current Filing Profiles	78
	Deleting a Current Filing Profiles	78
5	Starting a Scan from Your Mobile Device	79
	Making Preparation	79
	Connecting to A Wireless Network	80
	Connecting to a Wi-Fi network in an AP (Access Point) Mode ...	80
	Connecting the Scanner to a Wi-Fi Network in a Client Mode ...	81
	Connecting to a Wireless Access Point Using the WPS Button ..	83
	Scanning a Document from a Mobile Device	84
6	Customizing the Product's Configurations	86
	Customizing the Product's Configurations by the Touch Screen	87
	Customizing the Product's Configurations by the Product's Web Page .	87
	Summary of the Product's Configurations	89
	Configurations Customized Only Via the LCD Touch Screen	95
	Accessing the Service Mode	95
	Adjusting Brightness	96
	Selecting Language	96
	Configurations Customized Only Via the Product's Web Page	97
	Exporting and Importing System Data	97
	Accessing the Public Folder	98
7	Using the Product as a Regular Scanner	99
	Installing the Scanner Driver	99
	Connecting to the Computer	100
	Via a USB Cable	100
	Via a Wired Network	101
	Connecting to the Network Scanner	101
	Verifying Your Scanner Installation	103
	A Glance of the Scanner Properties Dialog Box	105

8	Using the Scanner Properties Dialog Box.....	106
	Buttons on the Scanner Properties Dialog Box	107
	Showing or Hiding Tabs.....	109
	The Image Tab	110
	The Image Selection Box	111
	Other Image Options	114
	Scanning Color Images	122
	Scanning Grayscale Images	122
	Scanning B&W Images.....	122
	Editing Profiles	123
	The Compression Tab	125
	The Color Dropout Tab.....	127
	Color Dropout Selection	127
	The Paper Tab	131
	Cropping	131
	Other Paper Selection	135
	The Multi-Feed Detection Tab.....	140
	The Preview Tab.....	142
	The Enhancement Tab	143
	The Rotation Tab	149
	The Separation Tab	154
	The Setting Tab	158
	The Imprinter Tab	160
	The Information Tab.....	164
9	ISIS Interface Operation	165
10	Scanning and Sending the Scanned Images to Your Computer (BM2 Air)	166
	Installing Button Manager V2.....	166
	Checking the Button Configurations before Scanning	167
	Scanning From One Touch of the Buttons.....	169
11	Troubleshooting	170
	Clearing Paper Jams.....	170
	Questions and Answers	171
	Errors Indicated on the Touch Screen	172
	Technical Support.....	185
12	Maintenance	187
	Cleaning the Touch Screen	187
	Cleaning the ADF	187
	Cleaning the Glass.....	189
	Replacing the ADF Reverse Roller.....	190
	Replacing the ADF Roller	194
13	Specifications	197

1 Getting Started

Introduction

Thank you for purchasing the network scanner. With the product, you can instantly scan single-sided or double-sided document(s) and deliver the electronic images to various destinations including E-mail addresses, ftp servers, network folders such as FTP, FTPS, FTPES, or cloud servers such as Google Drive, Evernote, OneDrive, or Microsoft SharePoint. In addition, the product also allows you to save the scanned image to an inserted USB flash drive, or the product's own memory.

If required, the product can be used as a regular scanner through USB or wired network connection to start a scan with your TWAIN-compliant software application and optimize your scanned images with various advanced image enhancement tool. You may refer to *Chapter 7 Using the Product As a Regular Scanner* in this manual on how to use this function.

Various Scan to Destinations

Scanning and Sending Your Images to an E-mail address:

Connected to an ethernet network and a SMTP server, the product allows you to transmit document(s) to your E-mail as attachment. With a touch of the E-mail key and the selection of your recipients' E-mail addresses, the document(s) is/are first scanned and converted into an image file, and then transmitted to remote recipients within minutes.

Scanning and Sending Your Image to a Cloud server or Network Folder:

The product allows you to send the scanned documents to a server such as Google Drive, Evernote, SharePoint Online or a network folder over intranet with FTP (File Transfer Protocol), FTPS (FTP Secure), FTPES, SharePoint, or SMB (Server Message Block Protocol). This feature off-loads the mail server from handling large attachments.

Scanning and Saving Your Images to a USB Flash Drive:

By plugging a USB flash drive into the USB port of the product, the product allows you to scan your document and save the scanned images to your USB flash drive.

Scanning and Saving Your Images to the Product's Memory:

By selecting a public folder as a filing destination, the product allows you to scan and save the scanned image in the product's memory and access the file from the product's embedded web page.

Preview:

Before sending your documents over the network, the product allows you to view a reduced size of the scanned document to verify if the scanned image has been skew, or upside down. If one of the pages is skew, you can delete and rescan that page to save your time.

Scancast:

Scan and broadcast the images respectively to various destinations including a cloud server, a public folder (the product's memory), a USB flash drive, E-mail addresses, a file server on the network such as FTP · FTPS · SMB.

Using Convenient Shortcuts:

By assigning your frequently used settings and scan to destinations as Shortcuts, the product allows you to streamline your workflow and complete your scanning task in just one press of a button.

Easy Customization:

This product makes user customization fast and easy by simply installing a third-party app (short for application) to be run on the product. The new plug-in app allows users to complete the scan tasks according to its own workflow.

Package Items

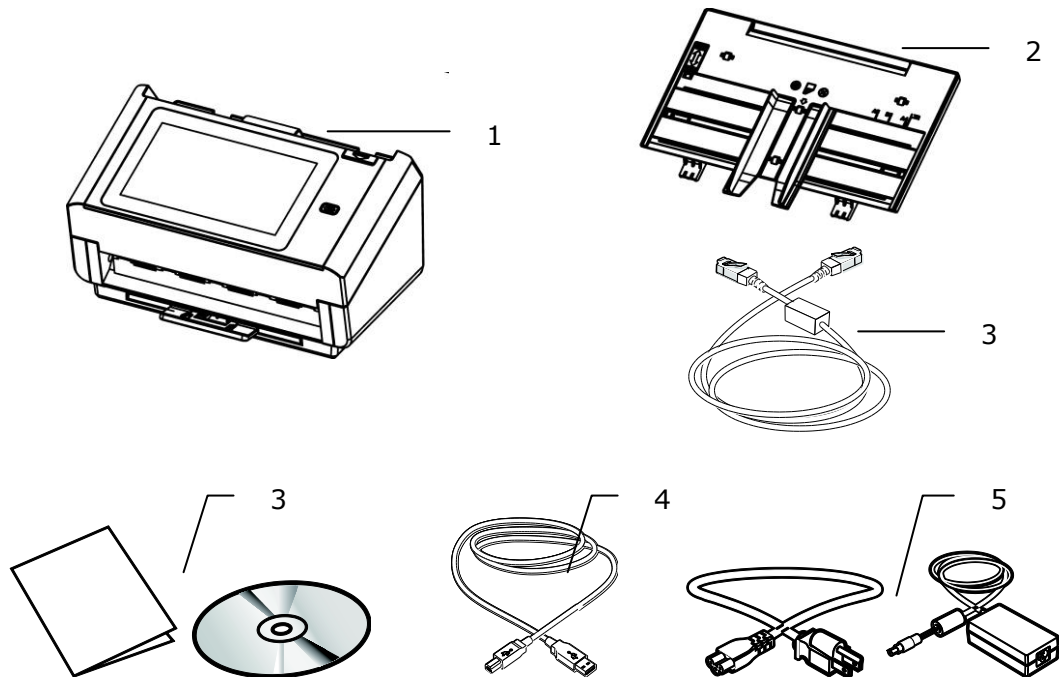

1. **Scanner Main Unit**
2. **ADF Paper Tray**
3. **Ethernet Cable**
4. **Software CD/Quick Guide**
5. **USB Cable**
6. **Power Adapter & Power Cord**

Note:

1. Only use the AC adapter DA-48M24 by APD included in the machine. Using other AC adapters may damage the machine and void the warranty.
2. Please unpack the packing carefully, and check the contents against the checklist. If any items are missing or damaged, please contact your dealer immediately.

External View

The Front View

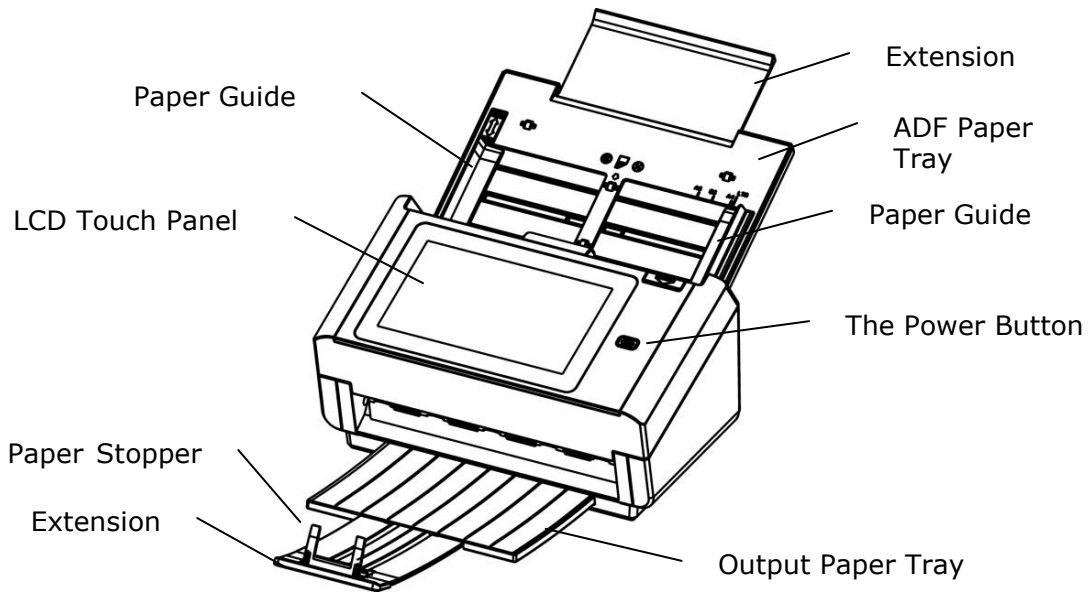

Part Name	Function
Extension	Can be pulled out and adjusted to the size of the document being scanned.
ADF Paper Tray	Load the document onto this part when scanning document.
Paper Guides	Adjusts to the width of the documents to prevent skewing of the scanned pages.
LCD Touch Panel	Operate the scanner through the touch screen.
Power Button	Press to turn on the power.
Output Tray	Open to collect the document after scanned.
Extension	Pull it out. Documents are ejected from the ADF to the tray.
Paper Stopper	Adjust to the length of the documents to prevent them from falling apart.

The Rear View

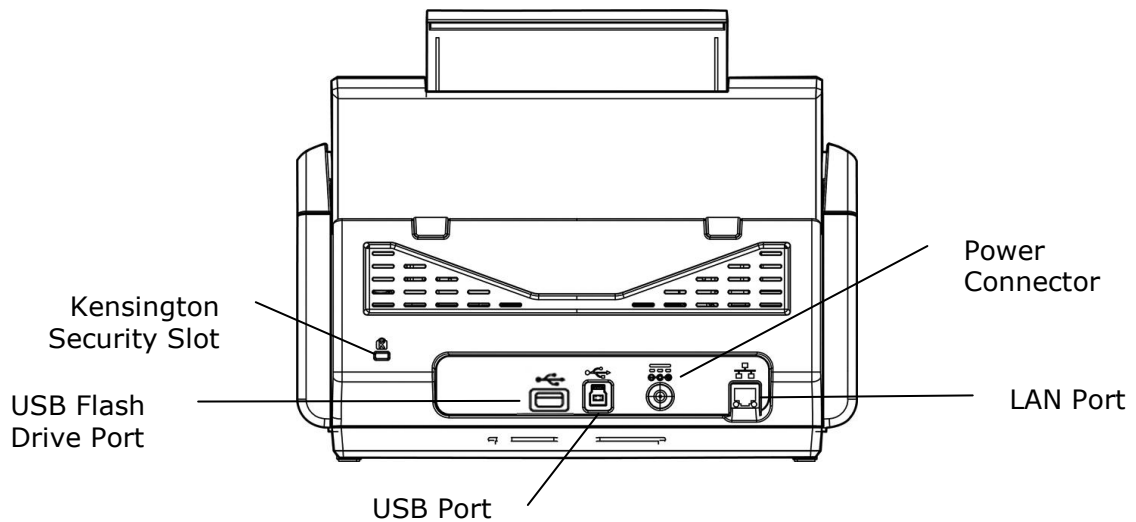

Part Name	Function
LAN Port	Connect the scanner to network with a LAN cable.
USB Port	<ul style="list-style-type: none"> • Connect to your computer via the supplied USB cable to use the device as a regular scanner. • Connect to your computer via the supplied USB cable to download firmware if required.
USB Flash Drive Port	Connect to USB flash drive or other USB device.
Power Connector	Connect the AC adapter to the scanner.
Kensington Security Slot	Attach to a lock to secure the scanner.

The Side View

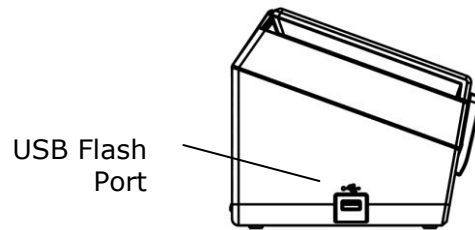

Part Name	Function
USB Flash Drive	Used to insert a USB flash drive.

Removable Parts

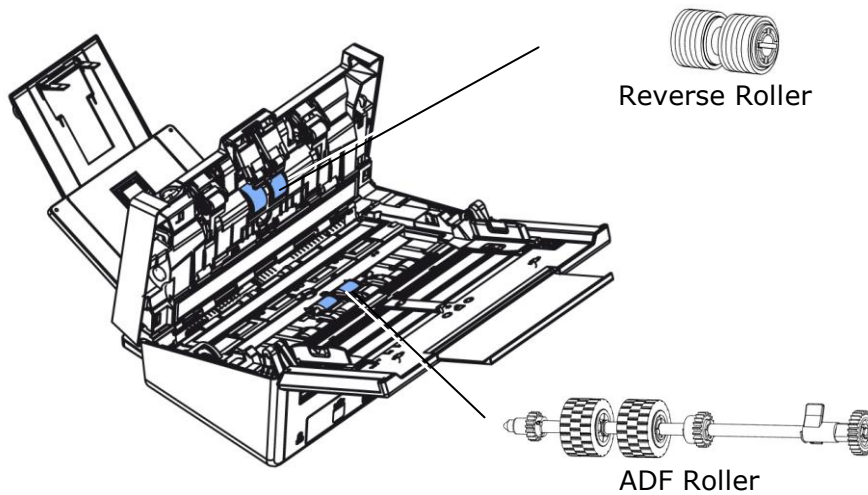

Pre-installation Information

Preinstallation

The product has to be setup properly on your network to perform E-mail and filing functions. The following network parameters have to be set.

Important!

Make a copy of the following table and ask your Network Administrator to complete the information.

1. DHCP Enable:	
2. IP Address:	. . .
3. Subnet Mask:	. . .
4. Gateway IP:	. . .
5. DNS Server:	. . .
6. Mail Server:	. . .
7. Port # of Mail Server	

Explanation of contents:



1. *DHCP Enable:	Choose Yes to obtain IP/subnet/gateway/DNS server/WINS server addresses automatically from DHCP server.
2. *IP Address:	The Internet Protocol (IP) address assigned to your machine by your network administrator or by DHCP server.
3. Subnet Mask:	The net mask address assigned by your network administrator or by DHCP server.
4. Gateway IP:	The gateway IP address assigned by your network administrator or by DHCP server or by DHCP server.
5. *DNS server:	The IP address of DNS server assigned by your network administrator.

Note:

- 1.** DHCP server: With DHCP (Dynamic Host Configuration Protocol), a host can automatically be given a unique IP address each time it connects to a network--making IP address management an easier task for network administrators. If the DHCP server is available from your network, you do not need to enter TCP/IP, subnet mask, gateway, and DNS information. Instead, this information will be automatically given for the product.
- 2.** IP Address: An IP (Internet Protocol) address uniquely identifies a host connection to an IP network. System administrator or network designer assigns the IP address. The IP address consists of two parts, one identifying the network and the one identifying your node. The IP address is usually written as four numbers separated by periods. Each number can be zero to 255. For example, 10.1.30.186 could be an IP address.
- 3.** DNS: Stands for Domain Name System. The DNS server identifies hosts via names instead of IP addresses. If the DNS server is available on your network, you can enter the domain name instead of digits for the IP address.

Frequently Used Buttons on the Touch Screen

The following table lists the frequently used buttons and their functions on the touch panel:

	<p>The [Start] button: Choose to start scanning the document and sending the scanned image to E-mail, Public Folder, USB Flash Drive, or other destinations.</p>
	<p>The [Back] button: Choose to leave current screen and return to previously operational screen.</p>
	<p>The [Home] button: Choose to leave current screen and return to the main operational screen.</p>

2 Installing Your Machine

This chapter is specifically targeted to the persons who are responsible for the administration of the product. It is recommended that the administrator read this chapter before installing the machine.

Minimum Configuration Requirements

To use the product as a network scanner, the following configuration is required:

To send E-mails from the product:

- TCP/IP network
- A Mail server

To file document(s) via intranet

- FTP, FTPS, FTPES, or SMB protocol environment

Installing the ADF Paper Tray

1. Hold the ADF Paper Tray and insert two pins to the holes on the top of the scanner as shown.

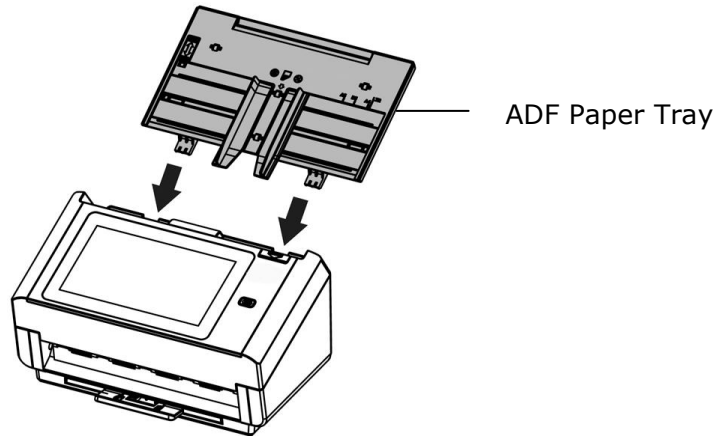

2. Pull out the extension to the length of the document.
3. Pull the Output Tray and raise the paper stopper to prevent the paper from falling.

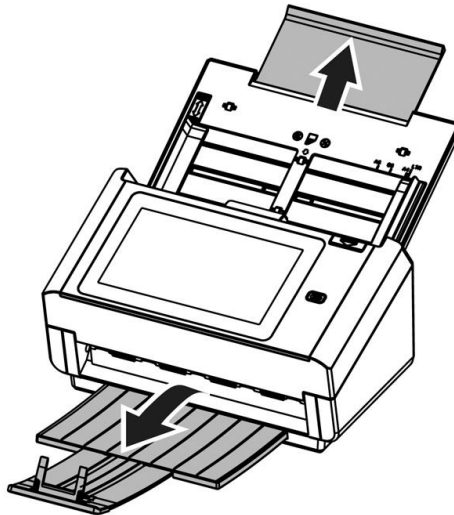

Connecting the Cables

Connecting the Ethernet Cable

1. Connect one end of your Ethernet LAN cable to an available port of your Ethernet Hub.
2. Connect the other end to the port marked  at the back of the product.

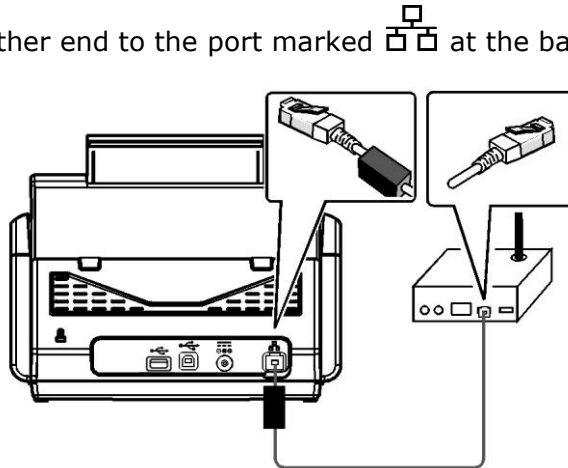

Connecting the Power and Turning on the Machine

1. Connect one end of the power cable to the power receptacle of the product.

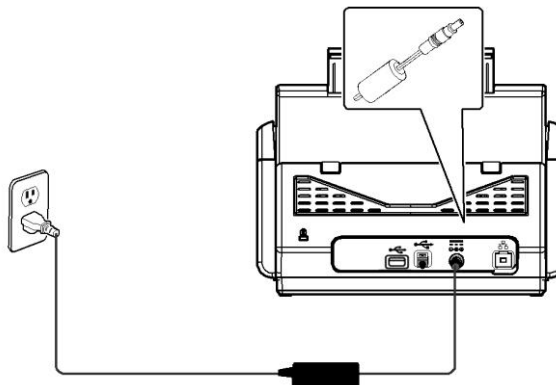

2. Connect the other end to an appropriate power outlet.

3. Press the [**Power**] button to turn on the product. The Power LED lights in green and the LCD Touch Panel will be displayed with a Home screen as illustrated.

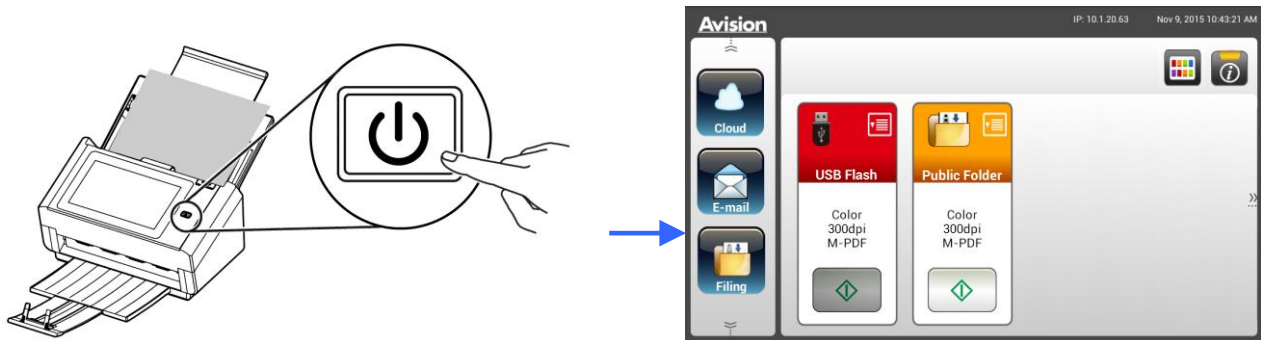

Note:

If the product will not be used for a long time, press the Power button for 3 seconds to turn off the power. Then unplug the product from the power outlet.

Turning Off the Machine

1. Press the **Power** button for at least 2 seconds. A Confirmation dialog box appears.

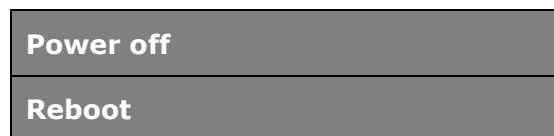

2. Tap [**Power off**] to turn off the machine or reboot to restart the machine.

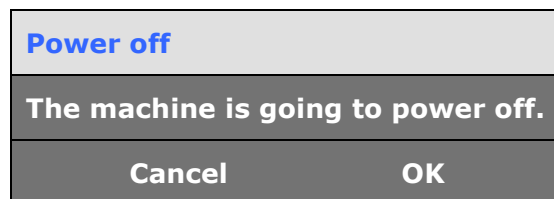

3. Tap [**OK**] to turn off the machine.

Selecting Your Language

The product provides various languages on the LCD Touch Panel. Choose your desired language to be displayed on the LCD Touch Panel.

1. Press the [**Power**] button to turn on the product. The LCD Touch Panel will be prompted with a Home Screen as indicated.

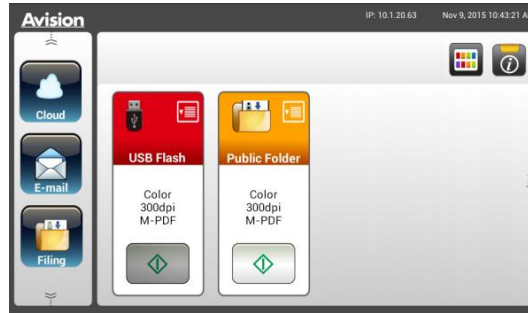

2. On the LCD Touch Panel, tap [**Settings**] > [**Device Management**] > [**Language**] in succession and then choose your desired language. Choice : English, Chinese Traditional, Chinese Simplified, Spanish, Portuguese, Hebrew.



3. Tap [**Save**] to save the setting.

Setting Date and Time

To let the product show current date and time, please set your date and time for the product before using it.

1. On the Home Screen of the LCD Touch Panel, tap [**Settings**]>[**Device Management**]>[**Date**] in succession and then set your current date.



2. Tap [**Save**] to save the setting and go back to the previous screen.
3. On the [**Device Management**] screen, tap [**Time**] to set your current time.
4. Tap [**Save**] to save the setting and go back to the previous screen.

Specifying the Product's TCP/IP Address

To let other devices on the network identify the product, you need to set an IP address for the product. Follow these steps to set an IP address:

1. On the Home Screen of the LCD Touch Panel, tap [Settings]>[Network]>[Wired] in succession and then set the IP address for the product.



- Check [DHCP] if you wish to enable DHCP.
- Check [Static IP] if you wish to specify a static IP address. If [Static IP] is selected, tap the **IP Address/Subnet Mask/Gateway IP/DNS Server** field respectively to bring up the soft keyboard and then enter the relevant values.

2. Tap [Save] to save the setting and go back to the previous screen.

Note:

- If the system administrator has chosen DHCP, then the IP address of TCP/IP, gateway, subnet mask, and DNS server will be automatically given.
- When installing the product for the first time, it is recommended that the Administrator retain the default system settings. The settings can be customized at a later date once you are familiar with the operation and functionality.

Specifying the Product's Mail Server

To send the scanned image to a recipient via E-mail, you need first specify your mail server information on the product. Follow these steps to set your mail server:

1. On the Home Screen of the LCD Touch Panel, tap **[Settings]>[Network]>[Mail Server]** in succession and then set your mail server information.



On the **Mail** server option, enter the IP address and port number of your mail server.

- On the **Authentication Method** option, tap **[ON]** to enable it or **[OFF]** to disable it.
- Tap anywhere respectively on the **Login Name/Password/Mail Server/ Port#** field to bring up the soft keyboard and then enter the relevant values.

2. Tap **[Save]** to save the setting and leave the screen.

Creating Your Address Book

To save the time in typing the E-mail address, you can create your address book to speed up the process.

1. On the Home Screen of the LCD Touch Panel, tap [**Settings**]>[**Address Book**]>[**New**] in succession and then enter your address information.

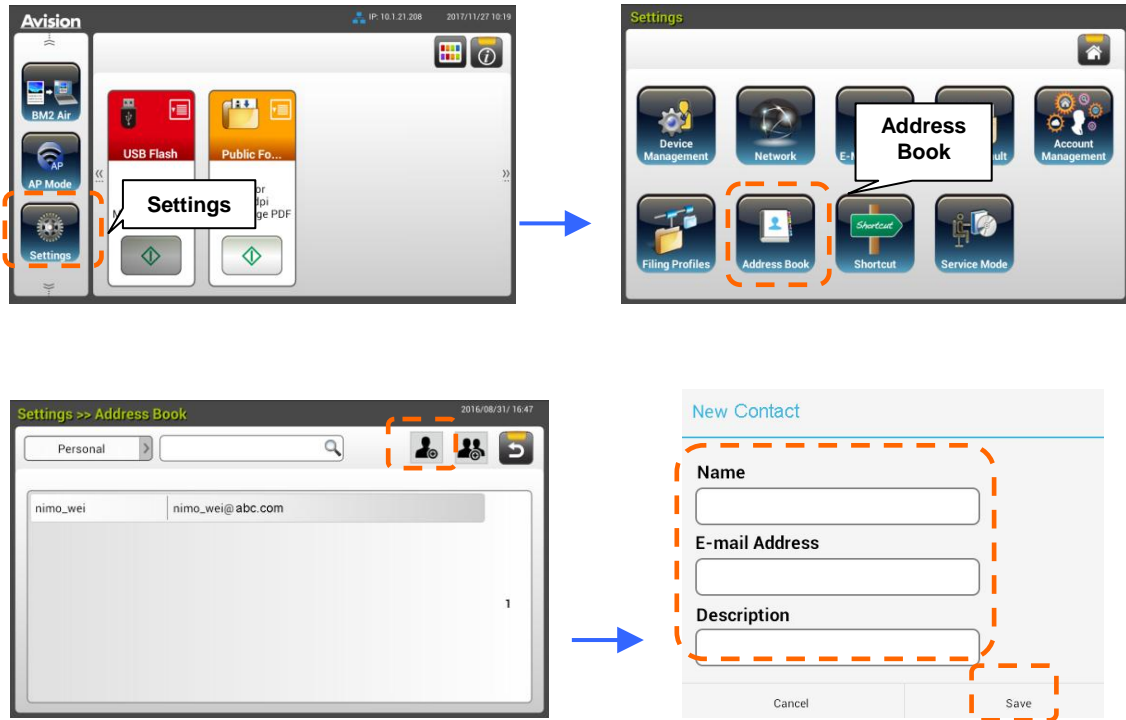

2. Tap [**Save**] to save the setting and leave the screen.

Creating Your Filing Profiles

To store your scanned image to the network folders, you need to first set up a few network folders including FTP, FTPS, FTPES, Public Folder, SharePoint, or SMB to store the images. You may first check with your System Administrator to make sure that you have the privilege to access these network folders.

1. On the Home Screen of the LCD Touch Panel, tap **[Settings]**>**[Filing Profiles]**>**[New]** in succession.



2. Refer to the following table to create your Filing Profiles. Tap **[Save]** after the settings have been made satisfactory.

Item	Description
Profile Name	Enter your profile name.
Scan to	Choose your [Scan to] destination protocol. Choice includes * FTP: //, FTPS: //, FTPES://, SMB: \\, USB, Public Folder, SharePoint. USB: Store the scanned image to an inserted USB flash drive. Public Folder: Store the scanned image to the memory of the product and then access the image via the product's embedded web page. SMB: Store the scanned image to someone else's computer in the network over intranet. FTP/FTPS/FTPES/SharePoint: Store the scanned image to the network folder over intranet.

Target URL	If FTPS, FTP, FTPES, SMB, or SharePoint is selected, enter the URL address. You can either enter a domain name or an IP address with the directory path. For example, 10.1.20.25/test
Port #	Enter the port number for the [Scan to] server.
Passive Mode	Set your FTP connection mode. Choice: On/Off (default: Off).
Login Name	Enter your login name to use the designated folder.
Password	Enter your password to use the designated folder.
File Name	Enter your default file name.
Output Color	Choose your desired default output color for the scanned image. Choice: *Color, Gray, B/W
Document Side	Choose your desired default scanning side. Choice: *1-Sided Face Down, 1-Sided Face Up, 2-Sided
File Format	Choose your desired default file format for the scanned image. Choice: JPEG, TIFF (One-Page TIFF), M-TIFF (Multi-Page TIFF), PDF (One-Page PDF), *M-PDF (Multi-Page PDF), Searchable PDF, PDF/A(M-PDF), PNG OCR Language (Searchable PDF): Choose your OCR language. With the OCR (Optical Character Recognition) engine which supports over a hundred of languages, your electronic documents can be searched and managed more effectively.
Resolution	The resolution is measured in pixels per inch (ppi) (sometimes referred to as dots per inch or dpi). Higher resolutions result in more detail in the scan, slower scanning and in general, greater file sizes. When OCR (Optical Character Recognition) is to be performed on a scan, 300dpi should be used for most languages except Asian languages. For Asian languages, 400 dpi is recommended.  Resolution: 150 dpi Resolution: 200 dpi Note: If you are scanning duplex (two-sided) paper in color mode, the max. resolution is 400 dpi. Choice: 100 dpi, 150 dpi, *200 dpi, 300 dpi, 400 dpi, 600 dpi.
*: Factory default	

Installing and Launching a Plug-In App (Optional)

This product makes user customization fast and easy by simply installing a third-party app (short for application) to be run on the product. The new plug-in app allows users to complete the scan tasks according to its own workflow. Follow these steps to install the plug-in app:

1. Open your browser and enter the product's IP address on the URL address. The product's embedded web page will be displayed.
2. Login the web page. (default user name and password: admin)
3. Click [**Device Management**] > [**Function Lock**], and turn on the [**App plug-in**] option. Click [**Update**] to complete.

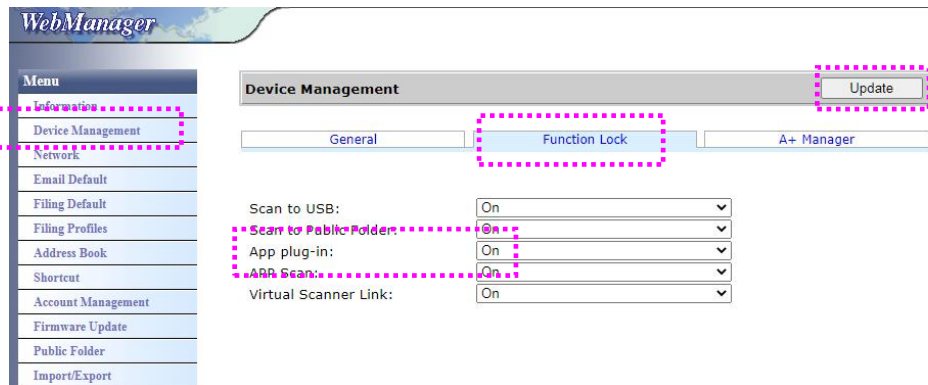

4. The [**App White List Setting**] and [**App Install/Uninstall**] options will be displayed at the Menu items.

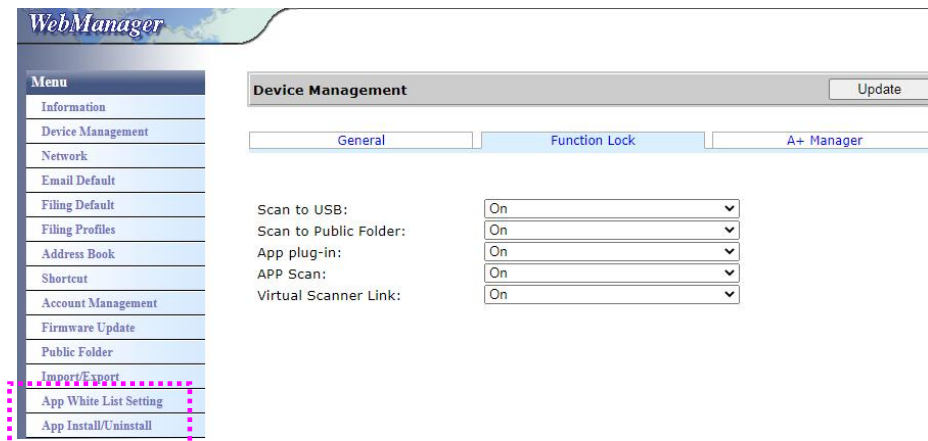

5. Click [**App White List Setting**] from the **Menu** option and then tap [**Browse**] to select the app name (in .spf file format) to be recognized by the product. Finally, click [**Update**] to complete.

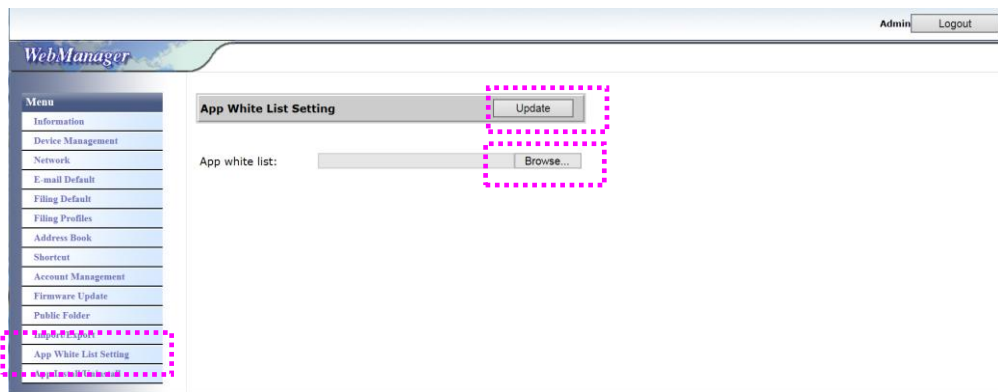

6. Tap [**App Install/Uninstall**] from the **Menu** option and then browse the installation file of your app and then tap [**Install**]. If successful, the new plug-in app will be displayed in the app list in below.

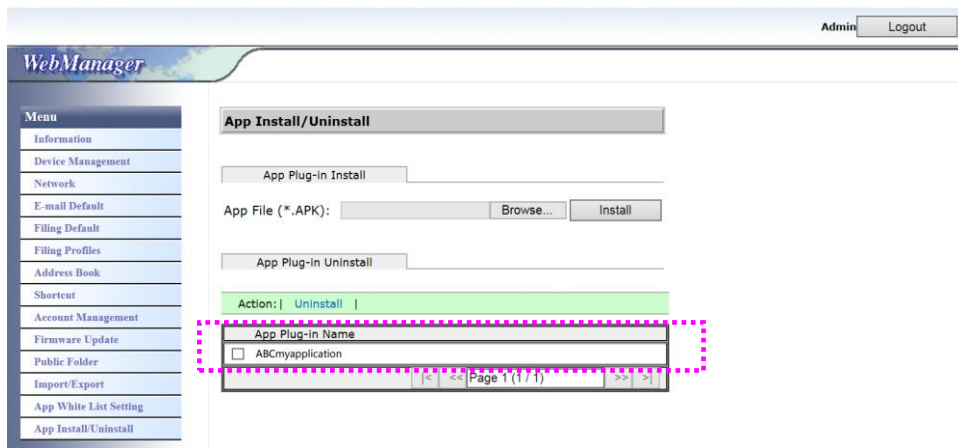

Note:

If you wish to uninstall the plug-in app, simply select the app name from the list and then tap [**Uninstall**]. The plug-in app will be uninstalled accordingly.

How to run the plug-in app on the product:

1. Install the plug-in app according to the steps described in the preceding section.
2. On the product's touch panel, tap [Settings]> [**Device Management**] > [**Function Lock**] in succession. Make sure the [**App plug-in**] is turned **ON**.

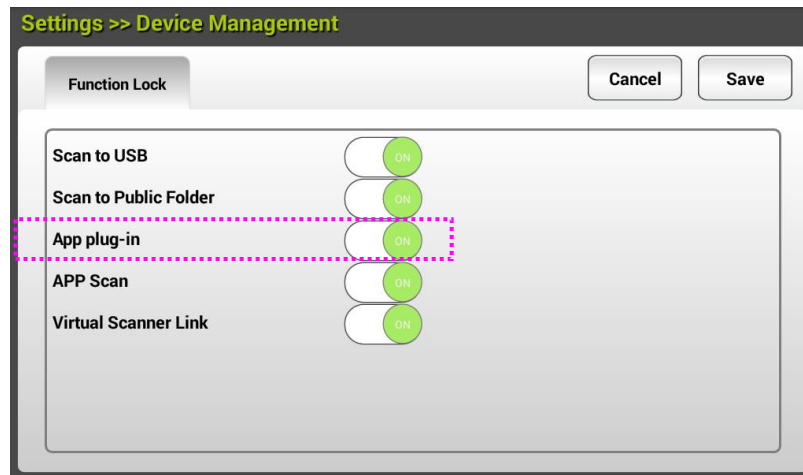

3. Scroll down the menu items on the right and then tap the [**plug-in**] icon. Launch the app by selecting the name of app.

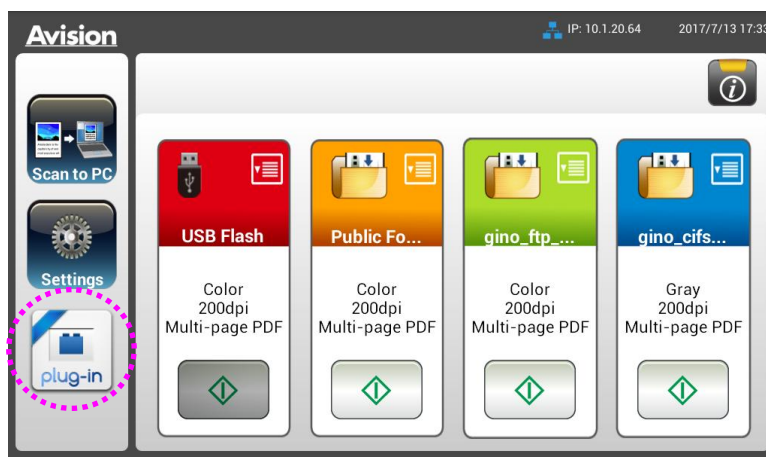

*Plug-in app: Support Android OS version 4.4 or below.

Setting the Plug-In App as the Default User Interface

After installing your plug-in application, you can set the plug-in application to be the default user interface after turning on the machine by the touch panel or the embedded website.

To set the plug-in app as the default user interface on the Touch Panel,

1. Tap [**Settings**] on the touch panel and login with default user name and password - admin.
2. Tap [**Plug-in**] and then [**Set APP as Default UI**].

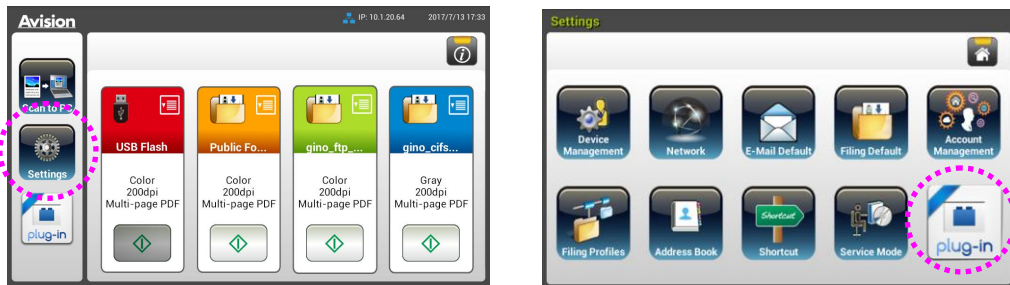

3. Enter your application name in the [**App Package Name**] field and then tap [**Save**] to complete.

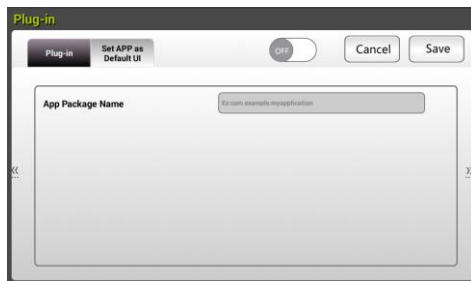

4. Restart the machine. Your application's user interface will be displayed.

To set the plug-in app as the default user interface on the website,

1. Open your browser and enter the product's IP address on the URL address. The product's embedded web page will be displayed.
2. Login the web page. (default user name and password: admin)
3. Choose [**App Install/Uninstall**] from the **Menu** option and select the [**Set App as Default UI**].
4. Check the [**Enable**] option and choose [**Update**] to complete.

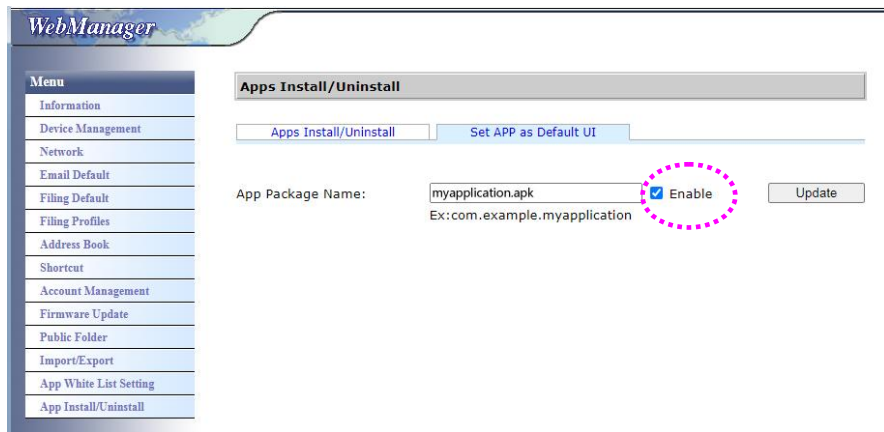

5. Restart the machine. Your application's user interface will be displayed.

Switching back to the Avision's User Interface

If you want to switch back to the Avision's (factory default) user interface, you can disable your application from the product's embedded website.

To switch back to the Avision's user interface,

1. Open your browser and enter the product's IP address on the URL address. The product's embedded web page will be displayed.
2. Login the web page. (default user name and password: admin)
3. Choose [**App Install/Uninstall**] from the **Menu** option and select [**Set App as Default UI**].
4. Uncheck the [**Enable**] button and choose [**Update**] to complete.

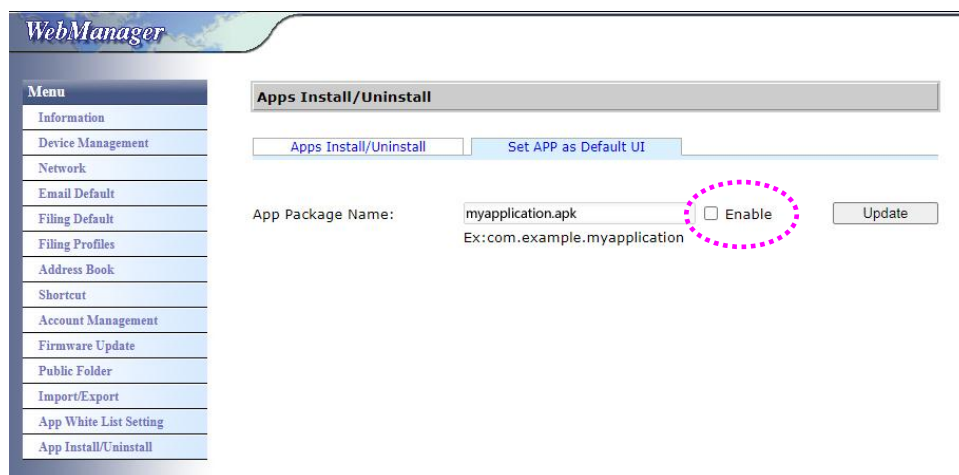

5. Restart the machine. The Avision's user interface will be displayed.

3 Operation

Document Loading Tips

Before using the ADF (Auto Document Feeder), please make sure that your paper meets the following specifications:

- Document(s) can range in size from 50 x 50 mm (2 x 2 in.) (A8) to 216 x 356 mm (8.5 x 14 in.) (Legal).
- Document(s) can range in weight from 7 to 110 lbs (27 ~ 413 g/m²)
- ID cards up to 1.25 mm (0.05 in.) thick
- Plastic cards compliant with the ISO7810 ID-1 type
- Document(s) should be square or rectangular and in good condition (not fragile or worn).
- Document(s) should be free of curl, wrinkle, tears, wet ink, or punch holes.
- Document(s) should be free of staples, paper clips, paper sticky notes.

Loading Document(s) in the ADF

Fanning Your Document

Note: To avoid occasional multi-feeds or paper jams, please fan your documents and align the top edges before feeding them into the scanner.

1. Hold both ends of the documents and fan them a few times.



2. Rotate the documents by 90 degrees and fan them in the same manner.
3. Align the edges of the documents in a step-like pattern (see picture below).

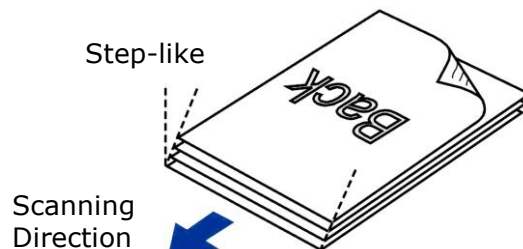

Document Feeding

1. Load the stack of document **face down** with the top of the pages pointing into the feeder.

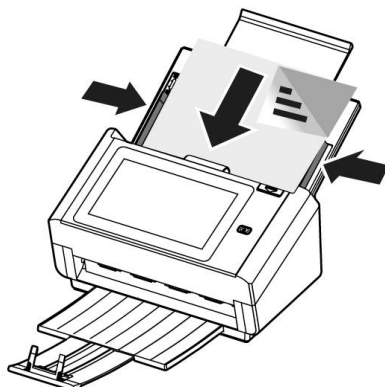

2. Verify that the paper guides are aligned with the edges of the stack.

Note: The [**Paper Width**] switch:

If your document width is 216 mm (8.5 in.):

If your document width is 216 mm (8.5 in.), slide the [**Paper Width**] switch **DOWN** to fix your paper guide to conveniently load the letter-size document.

If your document width is larger than 216 mm (8.5 in.):

If your document width is larger than 216 mm (8.5 in.) such as invoices with punch holes, slide the [**Paper Width**] switch **UP** and move the paper guide to the right end to load your documents.

Slide **DOWN** the [**Paper Width**] switch to set your paper width to 216 mm (8.5 in.)

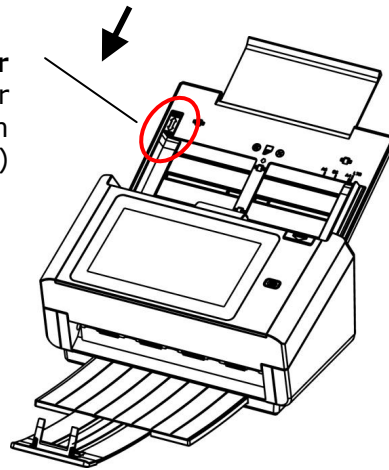

Slide **UP** the [**Paper Width**] switch to set your paper width larger than 216 mm (8.5 in.)

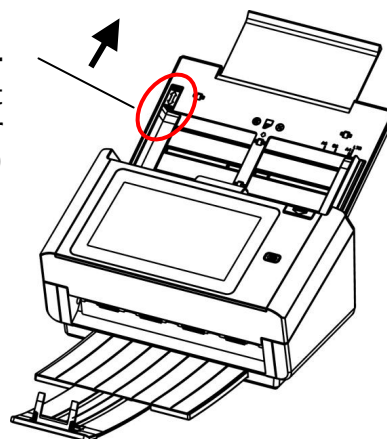

Scanning a Stack of Document with Various Sizes and Weights

When scanning a batch of documents with different sizes and weights, be sure to follow the following guidelines to avoid a skewed image or a paper jam:

- Align the documents **TOP EDGE** first in the sequence of paper size from large to small.

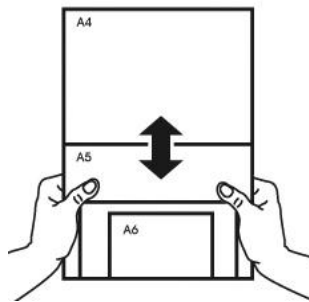

- If two pages are of the same size yet with different weight, arrange these pages in the sequence of paper weight from heavyweight to lightweight.

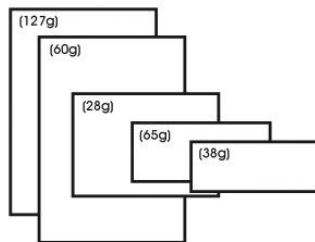

- Align the edges of the documents by tapping the bottom of the stack against the table top.

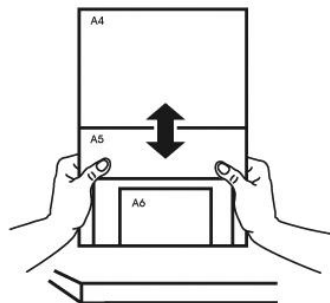

- Center these pages in the document feeder and make sure that the edges of page of the largest size slightly touch the Paper Guide.

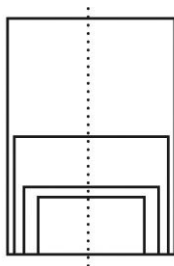

Scanning and Sending Your Document to E-mail Addresses

Basic Operation

Using the Default Setting

1. Load your document in the ADF with the 1st page facing down and the top of the pages pointing to the feeder.



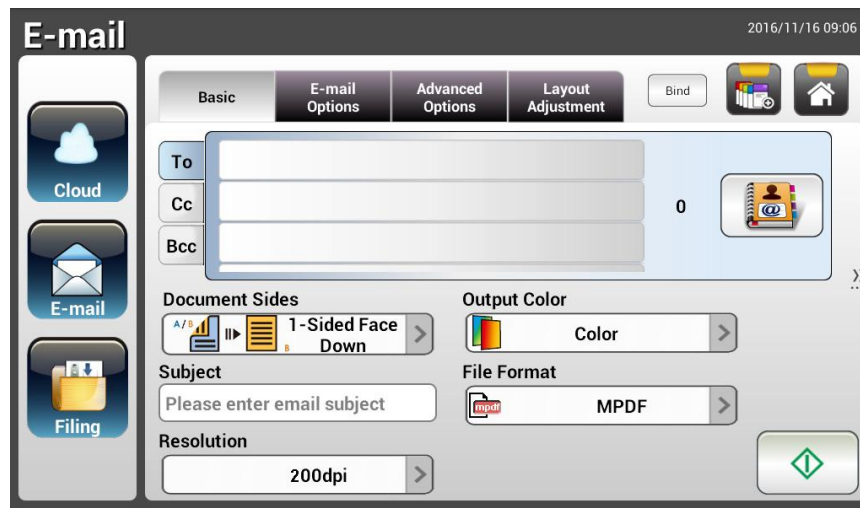

2. Press the **E-mail**  button on the Home screen. The following **E-mail** main screen will be displayed in the right side.



3. Enter the E-mail address.
 - Touch any place on the **"To"** field (the empty box in the center) to bring up the "soft keyboard" to type your email address. Tap the 2nd field to enter your 2nd E-mail address.
 - You can delete the E-mail address by touching the [**Delete**] button after you input your email address.
4. Enter or select CC and BCC address as well, if necessary. Enter the subject of your E-mail via the soft keyboard. If not, the "Default Subject" will be displayed in recipients' E-mail message.
5. Check if the Document Sides, Output Color, or File Format meets your requirements. If not, change the settings to suit your needs.
6. Tap the [**Start**] button () to start a scan.
7. The product starts scanning and the preview image will be displayed.



8. On the Preview screen,

- **Start:** If the scanned image is OK, press the [**Start**] button () on the touch panel to distribute the scanned image.
- **Remove:** If the scanned image is not satisfactory, tap the [**Remove**] button () to delete the scanned image.
- **Insert:** You may also insert more pages by tapping the [**Insert**] button () button.
- **Cancel:** If the scanned image is not OK, tap the [**Cancel**] button () to abort the job.

9. In a second, the scanned image will be sent to your E-mail addresses.

Advanced Operation

Using Special Settings

1. Load your document in the ADF with the 1st page facing down and the top of the pages pointing to the feeder.

2. Press the **E-mail**  button on the Home screen. The following **E-mail** main screen appears.

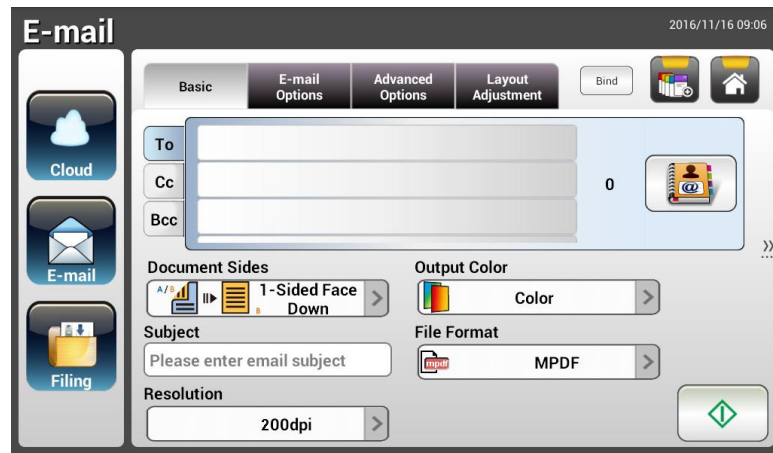

3. Enter your E-mail address.
 - Touch any place on the "To" field (the empty box in the center) to bring up the "Soft Keyboard" to type your email address. Press **Enter** to type the 2nd E-mail address and then click **Return** to return to the **E-mail** main screen.
4. Enter or select CC and BCC address as well, if necessary. Enter the subject of your E-mail via the soft keyboard. If not, the "Default Subject" will be displayed in recipients' E-mail message.
5. On the **Basic** screen, check if the document sides, output color, or file format meets your requirements. If not, change the settings to suit your needs.
6. Tap the **E-mail Options** tab to prompt the **E-mail Options** screen. Type your E-mail message if necessary in the **Message** field via the soft keyboard, enter the attachment name of the scanned document, and the "**Reply to**" address if necessary. (For more information about the settings, see the settings description in the next two pages.)
7. Tap the **Advanced Settings** tab to prompt the **Advanced Settings** screen. Change the density, contract, quality level, and resolution if the default settings are not satisfactory. (For more information about the settings, see the settings description in the next two pages.)





- Tap the **Layout Adjustment** tab to prompt the **Layout Adjustment** screen. Change original size, and preview if the default settings are not satisfactory. (For more information about the settings, see the settings description in the next page.)

- Press the **[Start]**  button to start a scan.

- The product starts scanning and the preview image will be displayed.



- On the Preview screen,

- Start:** If the scanned image is OK, press the **[Start]** button  on the touch panel to distribute the scanned image.
- Remove:** If the scanned image is not satisfactory, tap the **[Remove]** button  to delete the scanned image.
- Insert:** You may also insert more pages by tapping the **[Insert]** button  button.
- Cancel:** If the scanned image is not OK, tap the **[Cancel]** button  to abort the job.

- In a second, the scanned image will be sent to your E-mail addresses.

Settings Descriptions

Basic	
Item	Description
Document Sides	<p>Choice: *1-Sided Face Down, 1-Sided Face Up, 2-Sided</p> <p>1-Sided Face Down: Choose to scan single side of your document and make sure the scanning side faces down on the document feeder.</p> <p>1-Sided Face Up: Choose to scan single side of your document and make sure the scanning side faces up on the document feeder.</p> <p>2-Sided: If your original is a double-sided document, choose 2-Sided to scan both sides of your document.</p>
Subject	Enter text for your email subject. Up to 64 characters are allowed.
Resolution	<p>The resolution is measured in pixels per inch (ppi) (sometimes referred to as dots per inch or dpi). Higher resolutions result in more detail in the scan, slower scanning and in general, greater file sizes. When OCR (Optical Character Recognition) is to be performed on a scan, 300dpi should be used for most languages except Asian languages. For Asian languages, 400 dpi is recommended.</p> <div style="text-align: center;">  <p>Resolution: 150 dpi Resolution: 200 dpi</p> </div> <p>Note: If you are scanning duplex (two-sided) paper in color mode, the max. resolution is 400 dpi.</p> <p>Choice: 100 dpi, 150 dpi, *200 dpi, 300 dpi, 400 dpi, 600 dpi.</p>
Output Color	<p>Choose your desired output color for your scanned image.</p> <p>Choice: *Color, Gray, B&W</p> <p>Color: Choose Color if you wish to scan a color image for your original in color.</p> <p>Gray: Choose Gray image if your original contains actual shades of gray.</p> <p>Choose B&W if your original contains only text, pencil or ink sketch.</p>

File Format	<p>Choose the file format for your scanned image.</p> <p>Choice: JPEG, TIFF (One-Page TIFF), M-TIFF (Multi-Page TIFF), PDF (One-Page PDF), *M-PDF (Multi-Page PDF), Searchable PDF, PDF/A(M-PDF), PNG</p> <hr/> <p>Note:</p> <ul style="list-style-type: none"> ■ MPDF or MTIFF file format allows you to scan multi-page document and convert it to a single file. ■ PDF file format allows you to save one image page in a single file. ■ JPEG file format is available for Color and Gray images only. ■ TIFF file format is available for B&W images only.
* Factory Default	

E-mail Options	
Item	Description
From	Enter the " From " address of your outgoing mails from the product. If an E-mail can not be sent, notification is returned to this address. If the administrator has not set the device's email account in the Mail Server settings, you can enter the email address here. This is the " From " address in your E-mail when you receive an email from the product.
Reply To	Enter a " Reply to " address if you wish to specify a reply address which is different from the "From" address. Up to 60 characters can be entered in the field. To enter the address, you may press anywhere on the "Reply To" field to bring up the soft keyboard to type the address.
Message	Type your email message here. To enter the text, you may press anywhere on the " Message " field to bring up the soft keyboard to type the text.
File Name	Enter the file name for your scanned document without extension. If you have not entered a value in the box, the system will bring you a default file name, image. Using #n#Y#M#D#h#m#s makes file name change as time goes. (n, Y, M, D, h, m, and s represent series number, year, month, date, hour, minute, and second respectively.) For example, type file name: test#n#D will bring your filing file name as test000105
File Separation	Limit the file size of the attachment of each outgoing email to avoid the size limitation from SMTP servers. Use the combo box to select from the list. Choice: 5MB/10M/20M/30MB/*Unlimited
* Factory Default	

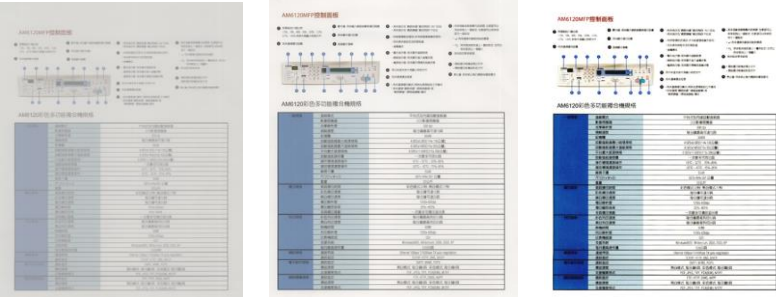
Advanced Settings	
Item	Description
Density	7 levels of density are provided to adjust the lightness or contrast of your document. If your original document is too light or too dark, you can use this setting to adjust the scanned image. Choice: Level -3~3. Default value: 0
Contrast	 <p>Contrast: -3 Contrast: 0 Contrast: 3 (Normal)</p> <p>Choice: Level -3~3. Default value: 0</p> <p>Adjust the Contrast slider right or left to increase or decrease the contrast.</p>
Remove Blank Page	If you wish to remove the blank page, you can adjust the sensitivity value to define the threshold. The higher the value, the more the sensitivity.
Quality/File Size	The options will be available only when "JPEG" format is selected in the Attachment Format option. Choose the quality level of your scanned image. The higher the quality, the larger file size. Choice: *Normal Quality/Small File, Higher Quality/Larger File, Highest Quality/Largest File
Document Type	Choose your document type. Choice: *Mixed, Photo, Text Text: Suitable for document contains pure text. Photo: Suitable for document contains photos. Mixed: Suitable for common business document with photo or text.
Multi-Feed Detection	Choose if you wish to enable the Multi-Feed Detection via ultrasonic unit. Ultrasonic Detection allows you to set overlapped document by detecting paper thickness between documents. Choice: On/*Off
Highlight	Used to adjust the brightness of the entire image. The smaller the number, the higher the brightness. Range: 128~*255
* Factory Default	

Layout Adjustments	
Item	Description
Original Size	<p>Press to select scan area.</p> <ul style="list-style-type: none"> ● Auto: Let the machine automatically detect the scan area according to your original. Detectable size: A4 · A5 · A6 · B5 · LGL · LTR ● Preset Scan Area: Specify your scan area from a list of A4, A5, B5, LTR (Letter), and LGL (Legal). <p>Choice: *Auto/Preset Scan Area</p>
Auto Orientation	<p>When Auto Orientation is turn On, images can be rotated to their proper orientations based on their contents. (*: off)</p>
Preview	<p>Turn on to display preview image in a low resolution to check if the scanned image is correct.</p> <p>Choice: *ON, OFF</p>
Carrier Sheet Mode	<p>Turn on this option to automatically crop the scan window according to your document size when scanning non-standard document (fragile, irregular-size document) with a carrier sheet (optional). On how to use the Carrier Sheet, please refer to the subsequent section in page 117.</p>
* Factory Default	

Settings for Various Mail Servers

When using the Scan-to-Email function, the machine will encounter various setting problems on mail servers and cause the mails to be sent unsuccessfully. This document is intended to help users to solve the settings problems. The following is the setting information for Gmail and Office365.

For Gmail

1. Setting on a Gmail Account

When using Gmail as Mail Server, due to security issues, you will be denied when you log in, and an error code 531534 will be displayed on the machine. There are two ways to solve it. One is to access less security app. The other is to enable 2-Step verification to generate a set of app password for the machine.

(1) Access less security app.

Please first apply a testing account - testxxx@gmail.com and a password - pwdxxx to specify the following settings:

- (a) Login Gmail mailbox, enter My Account and then select [Security] and click [Off] from the [Less secure app access] option.

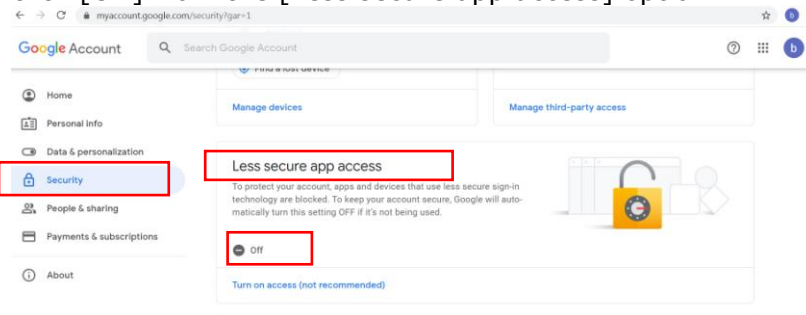

- (b) Turn on [Allow less secure apps: ON] as indicated.

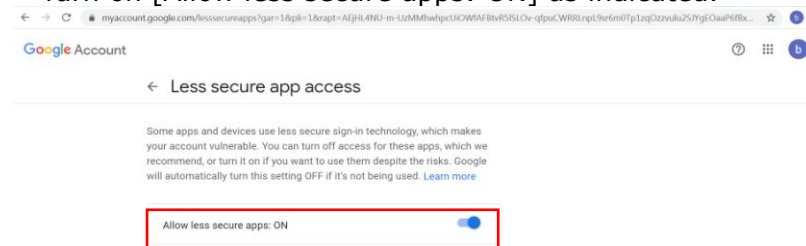

Then, the machine can directly use the login password on Gmail server.

(2) Enable 2-Step verification to generate App Password for the machine.

Turn on 2-Step verification:

- (a) Click [**My Account**] > [**Sign-in & security**] > [**Password & sign-in method**] in succession and then turn on [2-Step verification] as indicated in below.

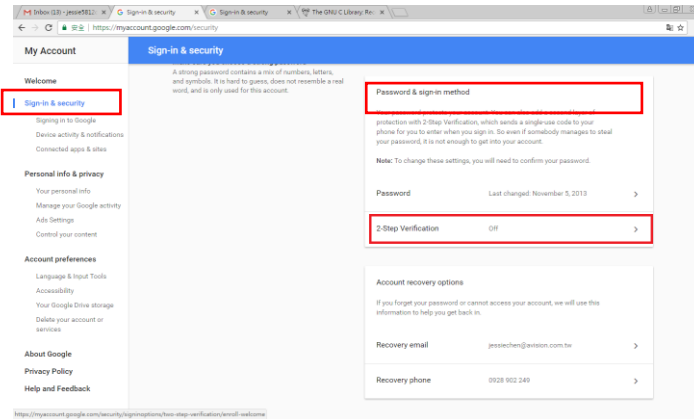

- (b) Click [**GET STARTED**] when the following dialog box is prompted.

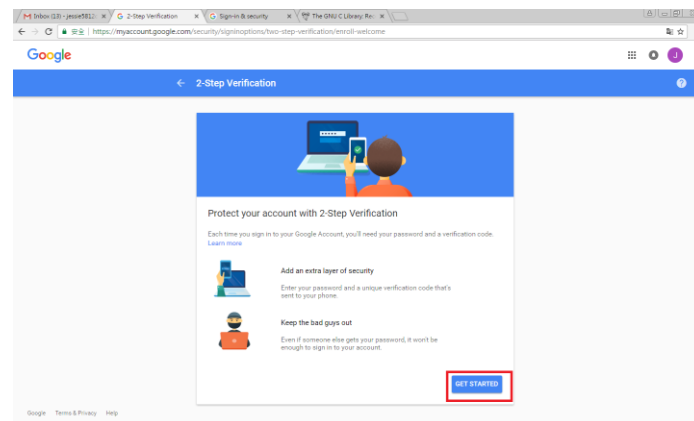

- (c) Enter your password and click [Next] when the new login screen is prompted.

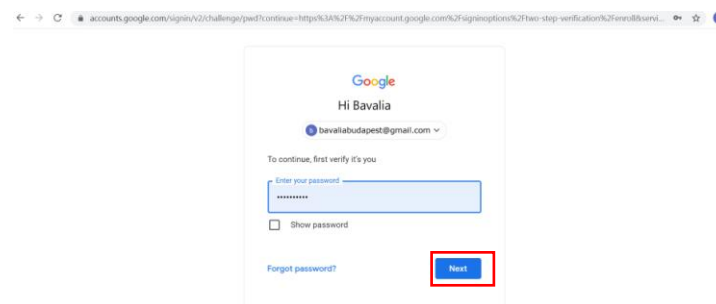

- (d) Enter your mobile phone number and then click [TRY IT] to get the verification code.

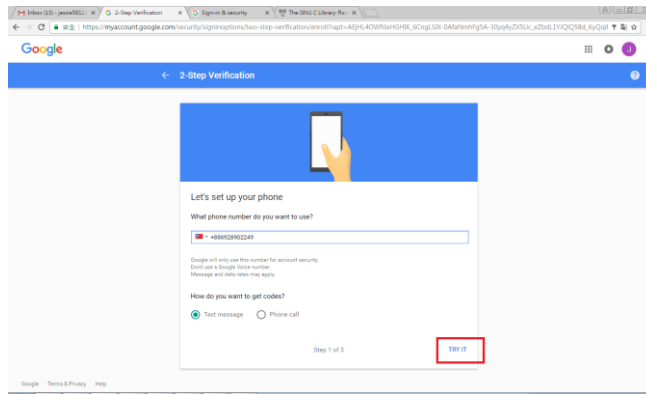

(e) Check the text message of your mobile phone and then enter the verification code in the following dialog box and click [Next].

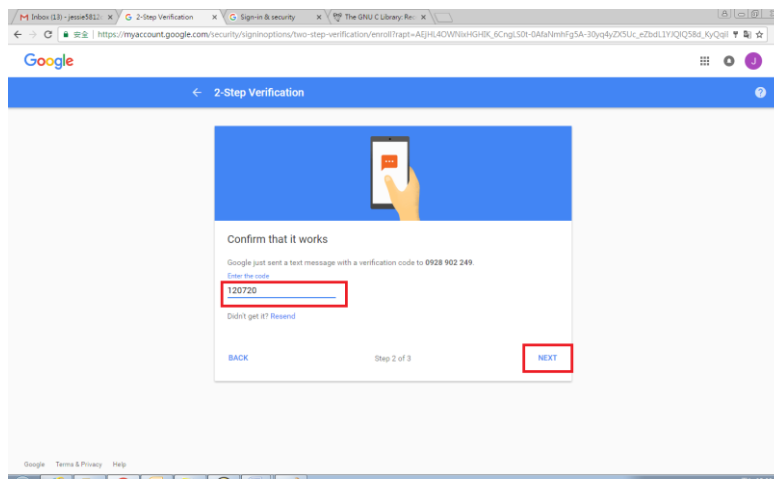

(f) Click [TURN ON] to complete the 2-Step verification.

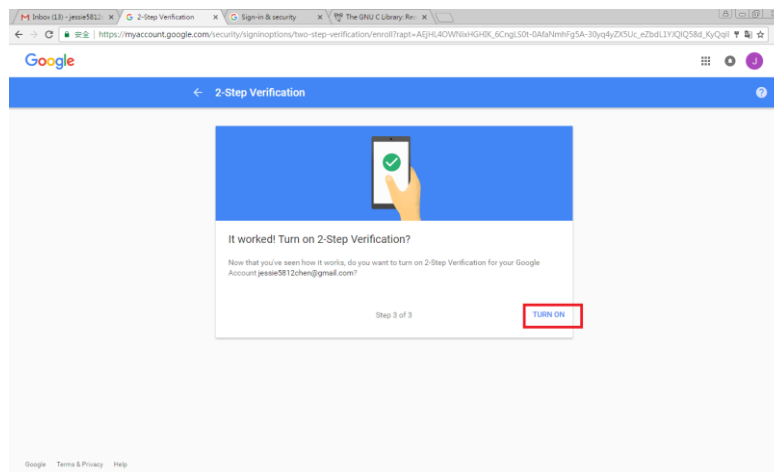

Generate App Password:

- (a) Return to [Signing in to Google] screen, an additional item - [APP passwords] will be added on the [Password & sign-in method] option as indicated in below. Click [>] as shown in the red box.

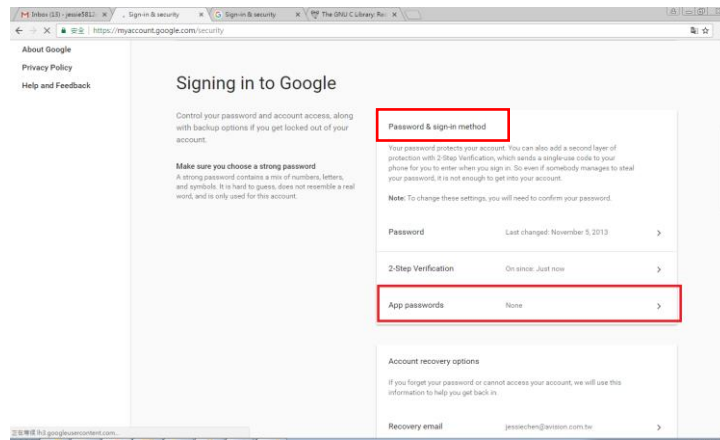

- (b) Choose [Other (custom name)] in the following screen.

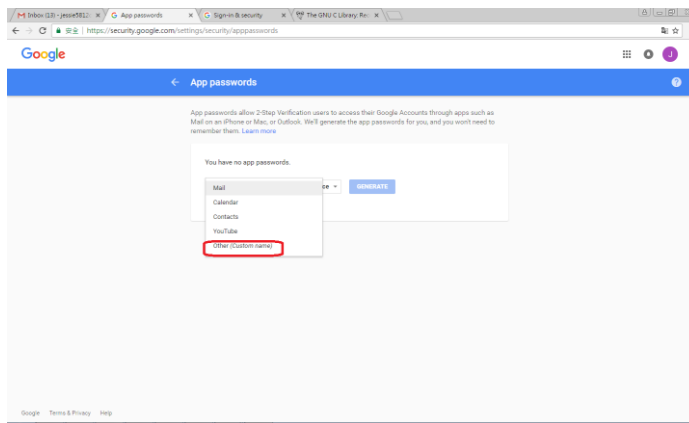

- (c) On the output device – MyScanner, click [GENERATE].

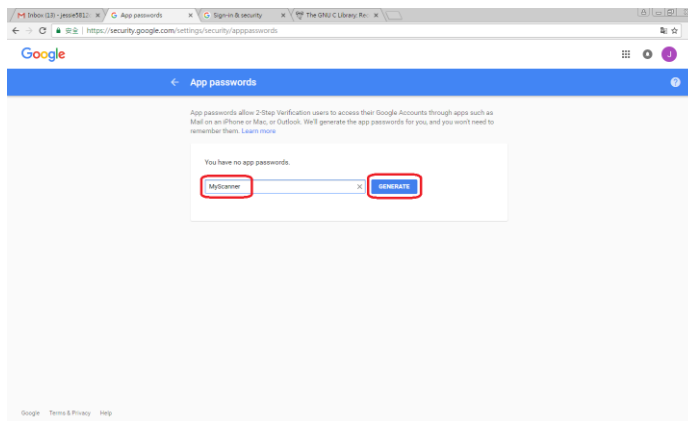

- (d) The white text on the blue background is your app password for the device. Make sure to copy the password first and then click [DONE]. Enter this password on the machine's mail server setting.

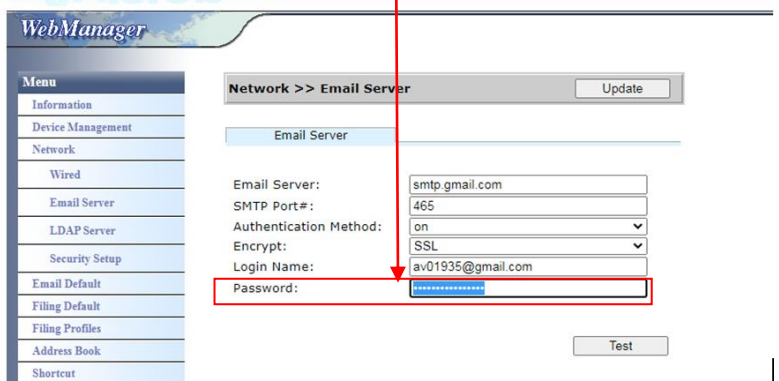
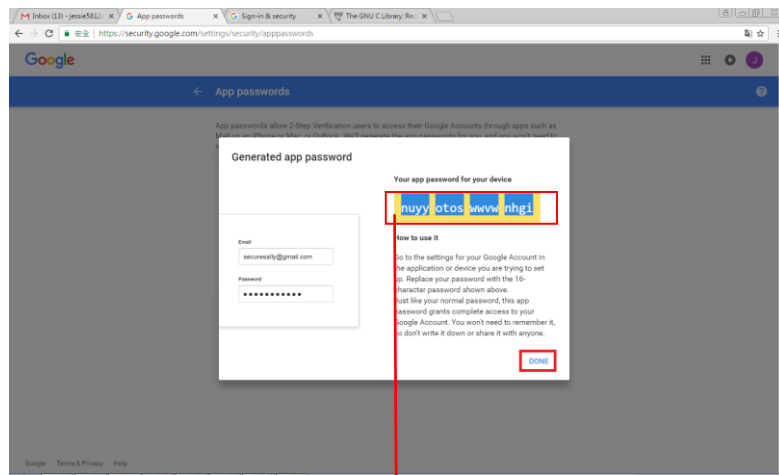

Settings on the Machine's Webpage

- Open your browser and type the machine's IP address on the URL address to open the device's embedded webpage.
- Choose [Network] to open the [Network Settings] page and enter Gmail's account and password. Be sure to add @gmail.com after the account and choose a encryption type, for example, SSL.

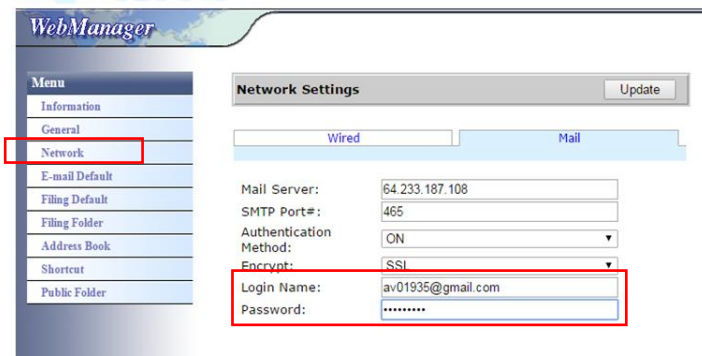

Note:

Gmail supports non-encryption connection yet you can only send mail to Gmail users. The setting is:

Mail Server: aspmx.l.google.com

SMTP Port#: 25

Authentication Method:off

Refer to <https://support.google.com/a/answer/176600?hl=zh-Hant>

For Office365

Check if Connection Line is OK

To use office365, you must go through an external line and make sure if connection is OK. The following is how to check if the connection is OK.

Take Option1 mail server as an example:

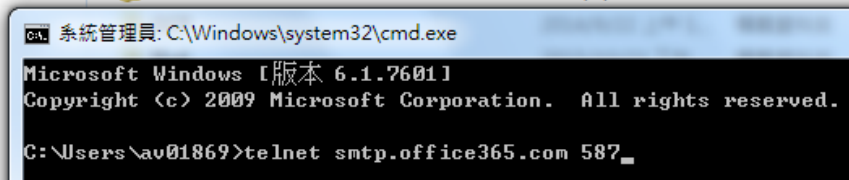

```
ca. 系統管理員: C:\Windows\system32\cmd.exe
Microsoft Windows [版本 6.1.7601]
Copyright (c) 2009 Microsoft Corporation. All rights reserved.

C:\Users\av01869>telnet smtp.office365.com 587_
```

If successful, the following screen will be prompted.

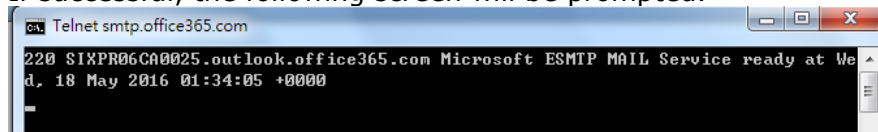

```
ca. Telnet smtp.office365.com
220 SIXPR06CA0025.outlook.office365.com Microsoft ESMT MAIL Service ready at We
d. 18 May 2016 01:34:05 +0000
```

The following link is a link to Office365. It contains informations for various options. This document will explain Option1, Option2 and Office365 mailbox.

[https://technet.microsoft.com/en-us/library/dn554323\(v=exchg.150\).aspx#option2](https://technet.microsoft.com/en-us/library/dn554323(v=exchg.150).aspx#option2)

(a) Option1

1. This option can send mail to outside mailboxes such as Gmail or yahoo. This method requires account and password login. The settings are:
Authentication: ON
Encrypt: STARTTLS
Port: 587
Mail Server: smtp.office365.com
Login Name : Network@tw.avision-global.com
Password : refer to Office365Pwd.txt

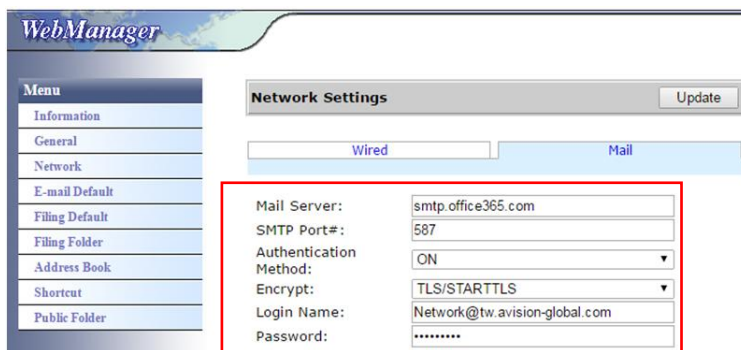

2. After completing the above setting, be sure to fill in the [From] field with your Office365 account. On the machine's touch panel, tap [E-mail]>[E-mail Options] and then enter Office365 account in the [From] field as shown in below.

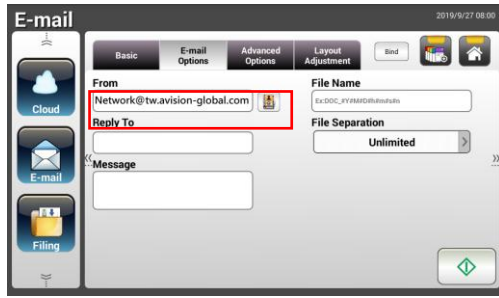

AN360 series

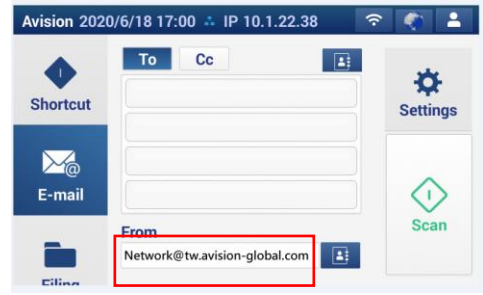

AN335 series

(b) Option2

This option can only send mail to office365 accounts that are also registered in the same group, and cannot sent mail to outside mailboxes. This method does not require account and password. Settings are as follows:

Authentication: OFF

Encrypt: None

Port: 25

Mail Server: contoso-com.mail.protection.outlook.com

The following screen shows the Office365 mail server applied by Avision)

(The Avision office365 mail server account:

tw-avisionglobal-com02e.mail.protection.outlook.com)

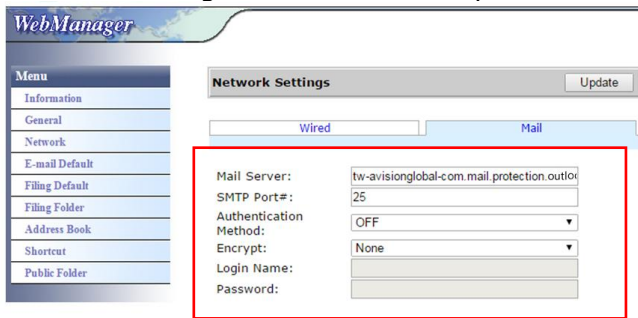

(c) Office365 Mail Box

Simply click [Mail] after login to Office365 as indicated in below.

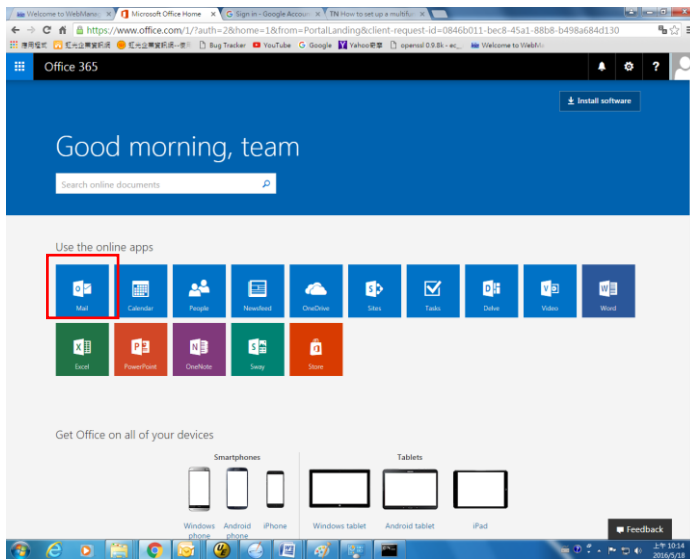

How to import e-mail address from a LDAP Server

1. Configuring Your LDAP Server Setting:

- (1). Open your browser and type the IP address of the device on the URL address. The webpage of the device appears.
- (2). Login the webpage. (default user name and password: admin)
- (3). Choose [**Network**] > [**LDAP Server**] > [**Authentication LDAP**] in succession.
- (4). Enter your LDAP information respectively and then click [**Update**] to complete. Refer to the following example.

Network >> LDAP Server Update

Email LDAP Authentication LDAP

LDAP Server IP or URL: 10.1.90.21
Port#: 389
Login Name: av01935
Password: *****
Search Root(Base DN): dc=avision,dc=com,dc=tw
Search attribute: cn
Obtain email address from: mail
Search Name from:
Get Account Name From: sAMAccountName
Ex:sAMAccountName
Timeout[seconds]: 5
Domain 1: avisionhq
Domain 2:
Domain 3:
Domain 4:
Domain 5:
Authentication Type: SIMPLE

Authentication LDAP Test

Select Domain: Domain 1 Test

- (5). You may try [**Authentication LDAP test**] to check if the connection and login test successful with admin's AD(ActiveDirectory) account.

2. Set Accounts with LDAP authentication:

- (1). On the device's webpage, choose [**Account Management**] and check [**Enable Security Management**] & [**Enable LDAP Authentication**].

Basic Account List

Enable Security Management Enable Guest Account Enable LDAP Authentication

Default Enable Function

<input checked="" type="checkbox"/> Shortcut	<input checked="" type="checkbox"/> Cloud	<input checked="" type="checkbox"/> Email	<input checked="" type="checkbox"/> Filing
<input checked="" type="checkbox"/> BM2 Air	<input checked="" type="checkbox"/> Scancast	<input checked="" type="checkbox"/> AP Mode	

- (2). Click the [**Account List**] tab, and click [**New**]. Check [**LDAP Authentication**].
- (3). Click [**LDAP Search**] and then enter your account and click [**Submit**] to search your AD account. The search result will be displayed as illustrated.

Account Management >> New Submit Quit

LDAP Authentication

User Name: LDAP Search

Password:

Email Address:

Enable Function

Shortcut Cloud Email Filing

BM2 Air Scancast AP Mode

LDAP Submit

User Group | Domain Domain1 (avisionhq) AV01935 search

CN	Name	Email Address
<input checked="" type="checkbox"/> 王振騰	AV01935	mark_wang@avision.com.tw
<input type="checkbox"/> AV01935-PC	AV01935-PC\$	mark_wang@avision.com.tw
<input type="checkbox"/> AV01935-20532	AV01935-20532...	mark_wang@avision.com.tw
<input type="checkbox"/> AV01935-20532...	AV01935-20532...	mark_wang@avision.com.tw
<input type="checkbox"/> AV01935-40675	AV01935-40675...	mark_wang@avision.com.tw

Page 1 (1 / 1)

3. Use your account to log-in your network scanner.

Account Management >> New Submit Quit

LDAP Authentication

User Name: LDAP Search

Password:

Email Address:

Enable Function

Shortcut Cloud Email Filing

BM2 Air Scancast AP Mode

Account Management

Basic Account List

Action: | [New](#) | [Delete](#) | [Modify](#) |

Account	Email Address
<input type="checkbox"/> avisionhq\AV01935	mark_wang@avision.com.tw

Page 1 (1 / 1)

To import email address from LDAP Mail Server:

- (1). Open your browser and type the IP address of the device on the URL address. The webpage of the device appears.
- (2). Login the webpage. (default user name and password: admin)
- (3). Choose **[Network]>[LDAP Server]>[Email LDAP]** in succession.
- (4). Enter your settings and click **[Submit]** to complete. Refer to the following example.

LDAP Setting >> Modify Submit Quit

Name:

LDAP Server IP or URL:

Port#:

Login Name:

Password:

Search Root(Base DN):

Search attribute:

Obtain email address from:

Search Name from:

Timeout[seconds]:

Authentication Type:

- (5). Then set a Mail LDAP.

Network >> LDAP Server

[Email LDAP](#) | [Authentication LDAP](#)

Action: | [New](#) | [Delete](#) | [Modify](#) |

LDAP name	IP/URL
<input type="checkbox"/> AvisionMail	10.1.90.21

- (6). Choose **[Address Book]>[External Address Book]** in succession.
- (7). Choose the Mail LDAP you have set.

Address Book

[Email List](#) | [Group List](#) | [External Address Book](#)

Action: | [New](#) | [Delete](#) | [Modify](#) |

Name	Email Address	Description
<input type="checkbox"/> Mark	av01935@gmail.com	

1/2000 |< << Page 1 (1 / 1) >> >|

- (8). Search your account, and choose **[Import to Email List]**.

10.1.20.109/iframe.htm - Google Chrome

Not secure | 10.1.20.109/iframe.htm

LDAP

Action: | [Import To Email List](#) | AvisionMail | Mark |

Name	Email Address
<input checked="" type="checkbox"/> 王振輝	mark_wang@avision.com.tw

1/2000 |< << Page 1 (1 / 1) >> >|

- (9). Finally, refresh your device's webpage, you will see your e-mail has been added to the address book from the LDAP Mail server.

Address Book

[Email List](#) | [Group List](#) | [External Address Book](#)

Action: | [New](#) | [Delete](#) | [Modify](#) |

Name	Email Address	Description
<input type="checkbox"/> Mark	av01935@gmail.com	
<input checked="" type="checkbox"/> mark_wang	mark_wang@avision.com.tw	

2/2000 | < << Page 1 (1 / 1) >> > |

Sending Your Document to a Network Folder, a USB Flash Drive or a Public Folder

Important:

To send your scanned images to a network folder such as FTP, FTPS, FTPES, or SharePoint, you may need to contact your System Administrator to get the correct URL for the specified server. Your System Administrator will also give you access to the site and a valid user login and password.

Basic Operation

Using the Default Settings

1. Load your document in the ADF with the 1st page facing down and the top of the pages pointing to the feeder.
2. Press the **Filing**  button on the Home screen. The following **Filing** main screen will be displayed.

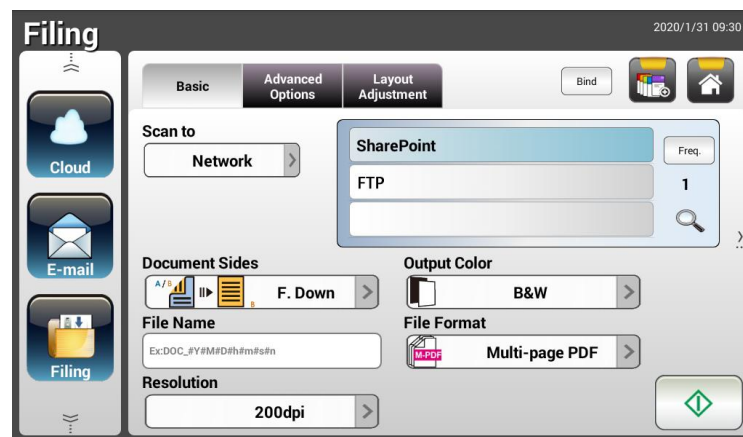





3. Choose a [**Scan to**] destination to store your scanned image.
 - Choose **Network** or **Local**.
 - If **Network** is selected, the available network servers including FTP, FTPS, or SharePoint will be displayed at the right box. You may use the **Up-arrow** or **Down-arrow** button to scroll from the list.
 - If **Local** is selected, **USB** and **Public Folder** will be displayed at the right box. If USB is selected, make sure a USB flash drive has been inserted to the USB flash drive port of the product.

If **Public Folder** is selected, the scanned image will be stored in the product's memory. Enter the PIN number (folder name) during scanning and then access the scanned image via the product's embedded web page. (Refer more detailed information on subsequent section - Customizing the Product's Settings via the Embedded Web Page.)

4. If desired, enter the file name prefix in the **[File Name]** field for the scanned document.
5. Check if the document side, output color, or file format meets your requirements. If not, change the settings to suit your needs.
6. Tap the **[Start]** () button. The scanner starts scanning your document.
7. The product starts scanning and the preview image will be displayed.



8. On the Preview screen,
 - **Start:** If the scanned image is OK, press the **[Start]** button () on the touch panel to distribute the scanned image.
 - **Remove:** If the scanned image is not satisfactory, tap the **[Remove]** button () to delete the scanned image.
 - **Insert:** You may also insert more pages by taping the **[Insert]** button () button.
 - **Cancel:** If the scanned image is not OK, tap the **[Cancel]** button () to abort the job.
9. Enter your user name or password when the Login window appears.
10. In a second, the scanned image will be sent to your specified destination.

Advanced Operation

Using Special Settings

1. Load your document in the ADF with the 1st page facing down and the top of the pages pointing to the feeder.



2. Press the **Filing** button on the Home screen. The LCD Touch Panel prompts the following **Filing** main screen.

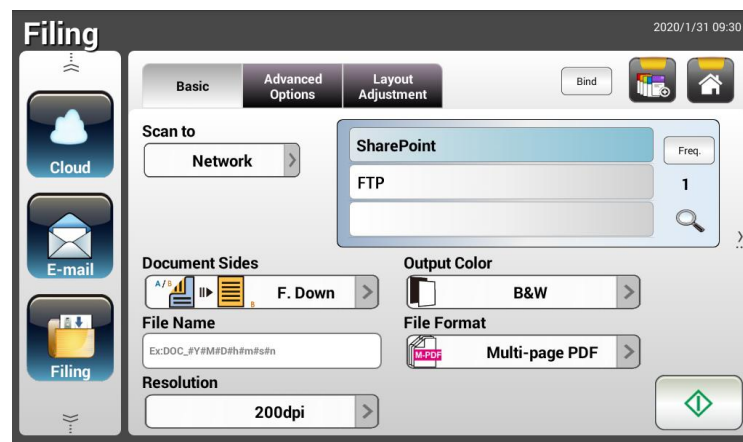

3. Choose your [**Scan to**] destination to store your scanned image.
 - Choose **Network** or **Local**.
 - If **Network** is selected, the available network servers will be displayed at the right box. You may use the **Up-arrow** or **Down-arrow** button to scroll from the list including SharePoint, FTP, FTPS.
 - If **Local** is selected, **USB** and **Public Folder** will be displayed at the right box. If **USB** is selected, make sure a USB flash drive has been inserted to the USB flash drive port of the product.

If **Public Folder** is selected, the scanned image will be stored in the product's memory. Enter the PIN number (folder name) during scanning and then access the scanned image via the product's embedded web page. (Refer more detailed information on subsequent section - Customizing the Product's Settings via the Embedded Web Page.)
4. On the **Basic** screen, enter your desired file name and check if document side, output color, or file format meets your requirements. If not, change the settings to suit your needs.
5. Tap the **Advanced Settings** tab to prompt the **Advanced Settings** screen. Change the density, contract, resolution, and quality level if the default settings are not satisfactory. (For more information about the settings, see the settings description described in the preceding section - Scanning and Sending Your Documents to E-mail Addresses on page 31.)





6. Tap the **Layout Adjustment** tab to prompt the **Layout Adjustment** screen. Change original size and preview if the default settings are not satisfactory. (For more information about the settings, see the settings description described in the preceding section – Scanning and Sending Your Documents to E-mail Addresses on page 30.)

7. Tap the **Start**  button. The scanner starts scanning your document.

8. The product starts scanning and the preview image will be displayed.



9. On the Preview screen,

- **Start:** If the scanned image is OK, press the [**Start**] button () on the touch panel to distribute the scanned image.
- **Remove:** If the scanned image is not satisfactory, tap the [**Remove**] button () to delete the scanned image.
- **Insert:** You may also insert more pages by taping the [**Insert**] button () on the bottom of the screen.
- **Cancel:** If the scanned image is not OK, tap the [**Cancel**] button () to abort the job.

11. In a second, the scanned image will be sent to your specified network folder.

How to Send Your Image to SharePoint

SharePoint (Server) is a web-based platform that your company owns and operates. You can use the web site as a secure place to store, organize, share information from any device through a web browser.

To add a SharePoint server for your filing profile,

1. Open your browser and type and IP address of your scanner. An embedded webpage appears.
2. Login the page to access more settings with default user name and password – admin.
3. Click [Filing Profile] and then [New] to create a new filing profile.

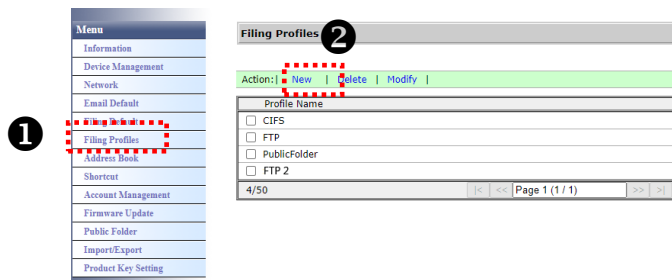

4. Enter your Profile Name. For example, SharePoint.
5. Select [SharePoint] from the [Target URL] field and then type the IP address or domain name of the SharePoint server provided by the IT department of your company as illustrated in below:

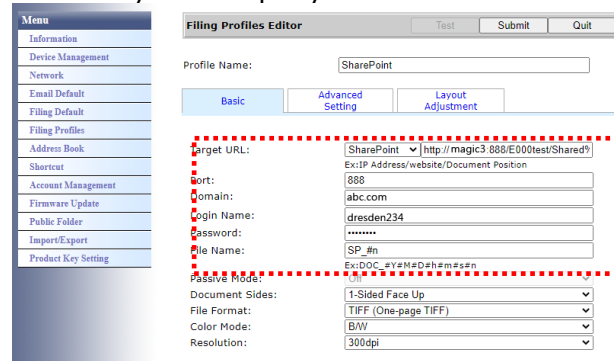

You may also check with your IT personnel for the server port, domain name and make sure that you have an authorized account.

6. Enter your login name and password.
7. Click [Submit] to complete the SharePoint settings.
8. If successful, a [SharePoint] profile will appear on the Profile list as shown in below.

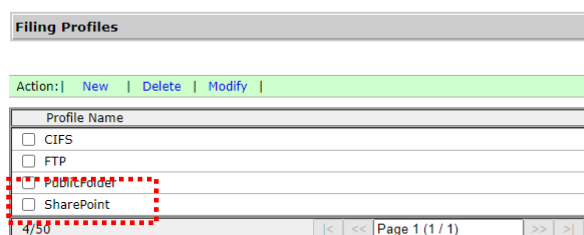

To scan and send your image to SharePoint Server,

1. For AN335W/AN360W series, tap [Filing] and then choose [Network] from the [Scan to] option. Finally, choose [SharePoint].

For AN335WL series, tap [Filing] and then choose [SharePoint].

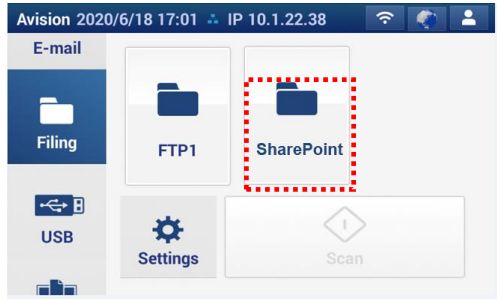

AN335L series

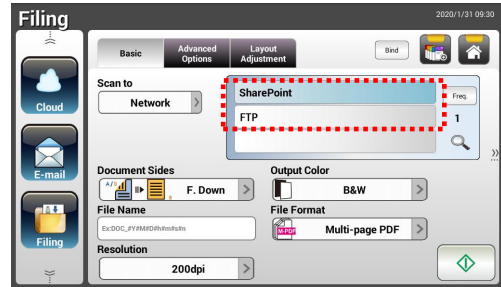

AN335W/AN360W series

2. Load your document to the scanner and then tap the [Start]  button.
3. In a second, the scanned image will be sent to the SharePoint server.

Sending Your Document to Clouds

Basic Operation

Important:

To send your scanned images to a cloud server such as Google Drive, Evernote, OneDrive, and SharePointOnline, make sure you have the privilege to access the cloud servers. For example you need to create a login name and password first.

Using the Default Settings

1. Load your document in the ADF with the 1st page facing down and the top of the pages pointing to the feeder.

2. Press the **Cloud**  button on the Home screen. The LCD Touch Panel prompts the following **Cloud** main screen.

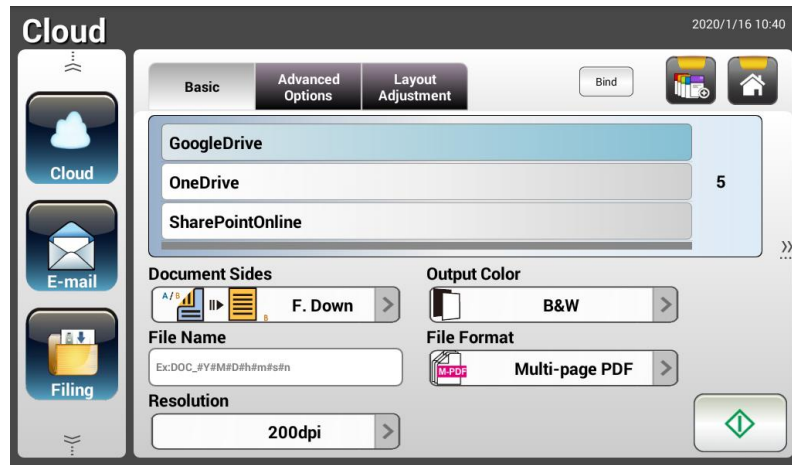

2. Choose your desired cloud server to save your scanned images. **Choice: GoogleDrive, OneDrive, SharePointOnline, Evernote.**





3. Check if the document side, output color, or file format meets your requirements. If not, change the settings to suit your needs.

For SharePointOnline, you may enter your desired group site name to store your scanned image. Otherwise, the image will be sent to a default group site name.

4. Tap the **Start**  button. The scanner starts scanning and a Preview screen will be prompted.



5. On the Preview screen,

- **Start:** If the scanned image is OK, press the [**Start**] button () on the touch panel to distribute the scanned image.
- **Remove:** If the scanned image is not satisfactory, tap the [**Remove**] button () to delete the scanned image.
- **Insert:** You may also insert more pages by tapping the [**Insert**] button () button.
- **Cancel:** If the scanned image is not OK, tap the [**Cancel**] button () to abort the job.

6. The product begins to upload your scanned images to your specified cloud server.

On the web site of your specified cloud server, you will be required to complete the login and authorization. If successful, your account will be displayed and the scanned image will be stored in the cloud server.

Advanced Operation

Using Special Settings

1. Load your document in the ADF with the 1st page facing down and the top of the pages pointing to the feeder.





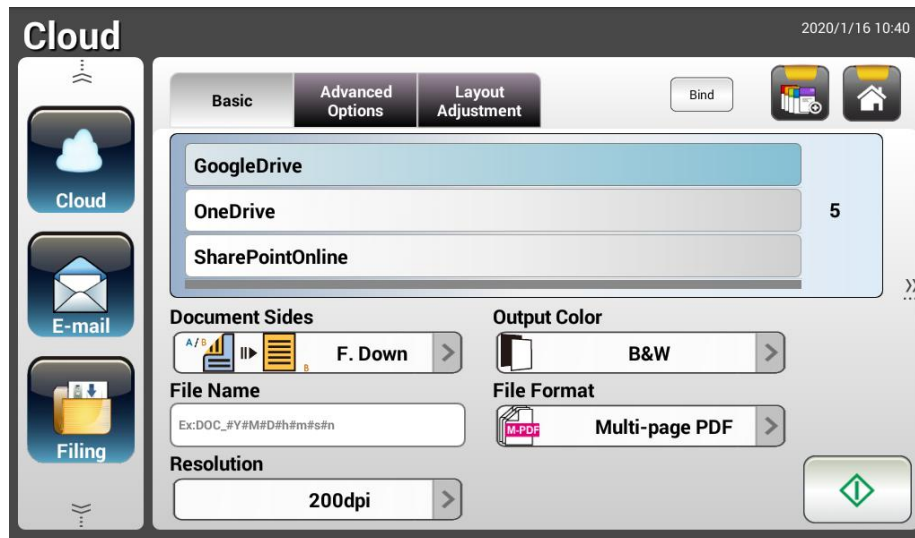

2. Press the **Cloud** button on the Home screen. The LCD Touch Panel prompts the following **Cloud** main screen.



3. Choose your desired [**Scan to**] cloud server to save your scanned images. **Choice: Google Drive, OneDrive, SharePointOnline, Evernote.**
4. On the **Basic** screen, check if the document sides, output color, or file name meets your requirements. If not, change the settings to suit your needs.
5. Tap the **Advanced Settings** tab to prompt the **Advanced Settings** screen. Change the density, sharpness, contract, saturation, and quality level and select resolution of the scanned image if the default settings are not satisfactory. (For more information about the scan settings, please refer to the preceding section – Scanning and Sending Your Documents to E-mail Addresses on page 31.)
6. Tap the **Layout Adjustment** tab to prompt the **Layout Adjustment** screen. Change original size and original orientation if the default settings are not satisfactory. (For more information about the scan settings, please refer to the preceding section – Scanning and Sending Your Documents to E-mail Addresses on page 33.)
7. Tap the **Start**  button. The scanner starts scanning your document.



8. On the Preview screen,

- **Start:** If the scanned image is OK, press the [**Start**] button () on the touch panel to distribute the scanned image.
- **Remove:** If the scanned image is not satisfactory, tap the [**Remove**] button () to delete the scanned image.
- **Insert:** You may also insert more pages by taping the [**Insert**] button () button.
- **Cancel:** If the scanned image is not OK, tap the [**Cancel**] button () to abort the job.

9. The product begins to upload the scanned images to your specified cloud server.

On the web site of your specified cloud server, you will be required to complete the login and authorization. If successful, your account will be displayed and the scanned image will be stored in the cloud server.

How to Send Your Image to SharePointOnline

SharePoint Online, a platform within Microsoft Office 365, is a cloud-based service provided directly by Microsoft.

To set SharePointOnline Setting:

1. Open your browser and type and IP address of your scanner. An embedded webpage appears.
2. Login the page to access more settings with default user name and password – admin.
3. Click [ShortCut]>[New]>[Cloud] in succession to create a new ShortCut to speed up the process.

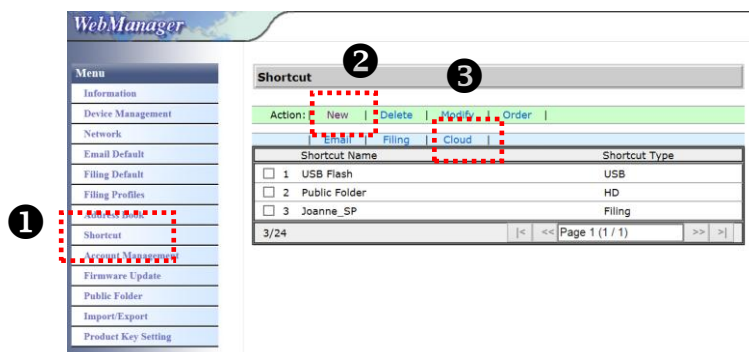

4. Enter your Shortcut Name. For example, ShortPointOnline.
5. Select [SharePointOnline] from the [Target URL] field.
6. Enter your subfolder name to store the image. For example, bess. (You can create next subfolder by adding "/", for example, bess/invoice.
7. Enter your site address (group name). For example, 789. Or using default site address to be stored in [Group website] site.

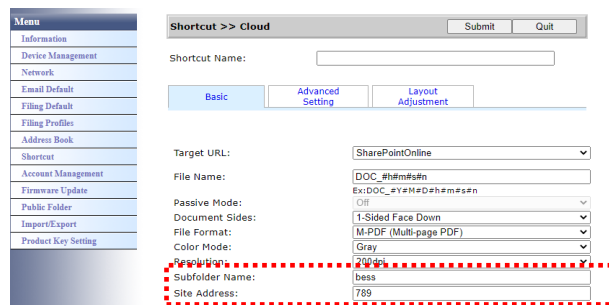

8. Click [Submit] to complete the settings.
9. If succesful, a new SharePointOnline will be added to the list as indicated in below.

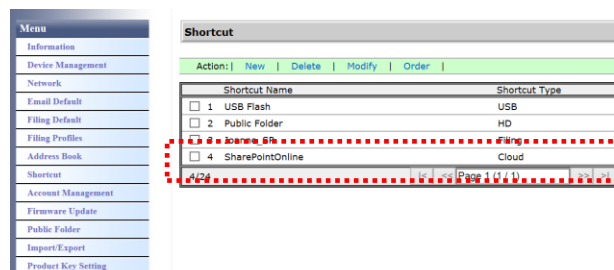

To scan and send the image to SharePointOnline:

1. Load your document to the scanner.
2. On the touch panel, tap the [Start]  button of the [SharePoint] shortcut.

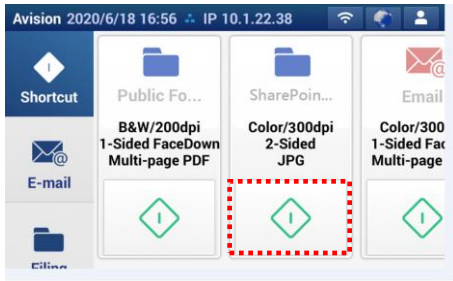

AN335L series

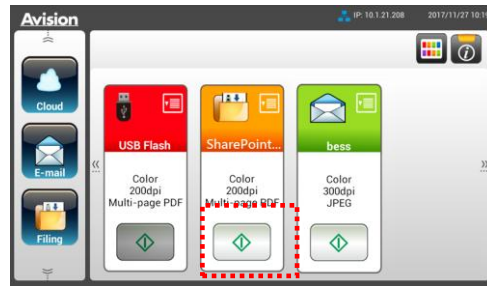

AN335W/AN360W series

3. When the following [Sign in] dialog box is prompted, type your account name, password, and then click [Next]. Click [Yes] when [Stay sign in] dialog box is prompted.

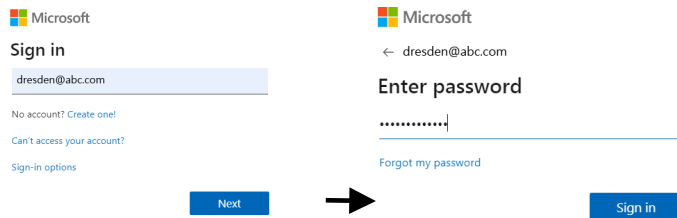

4. The scanned image will be delivered to your SharePointOnline Cloud.
5. Open your browser and type the IP address/domain name of your company's SharePointOnline server. You can find your image in the SharePointOnline page as shown in below. (Group name: 789, Subfolder: bess)

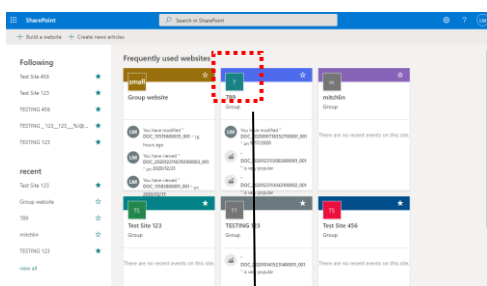

Group Name

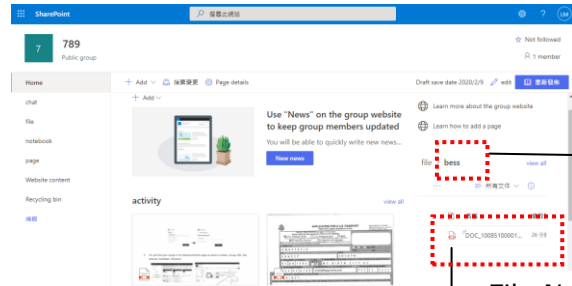

Your Subfolder

File Name

Creating a Shortcut Button

By setting frequently used scan settings and destinations as Shortcut on the Home screen, the product helps you to streamline your workflow and complete your scanning task in just one single step.

Plus, if the cloud server has been setup as a shortcut button on the main screen, the login name and password will be remembered to save you the trouble of having to enter the information each time you access the cloud server.

To create a Shortcut button,

1. Select your frequently operational mode on the left panel. For example, E-mail. The E-mail screen will be displayed on the right panel.

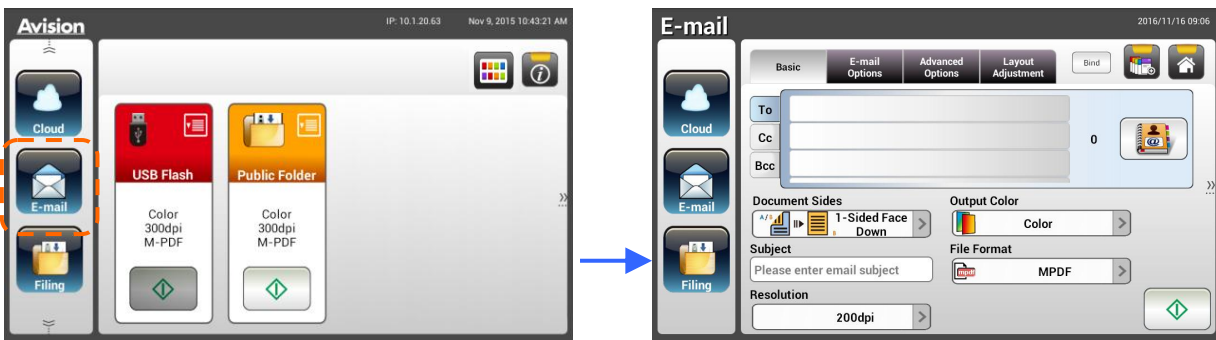

2. Select your frequently used E-mail address in the [To]/[CC]/[BCC] field.

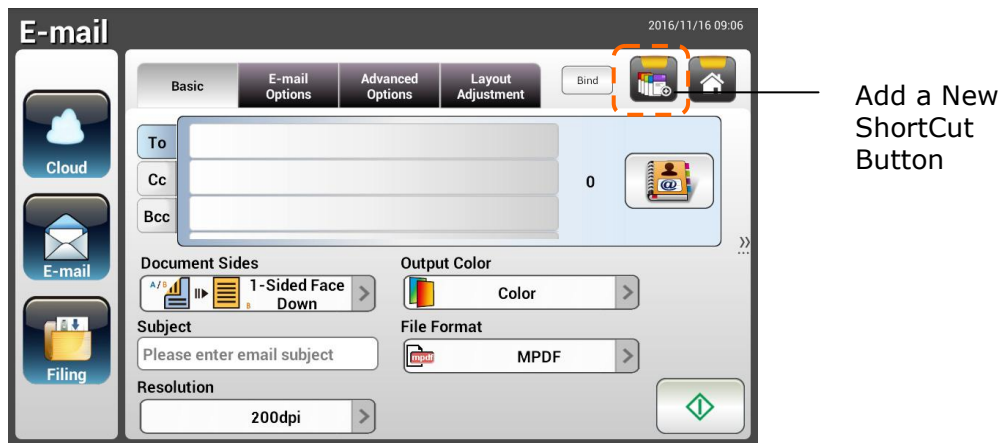

3. On the [E-mail options] screen, type your [From] address.
4. Check if any of the scan settings needs to be changed to suit your frequently used E-mail task.
5. If the scan settings are satisfactory, tap the [New ShortCut]  to create your new ShortCut.

6. An [**Enter a Shortcut Name**] dialog box will be prompted.

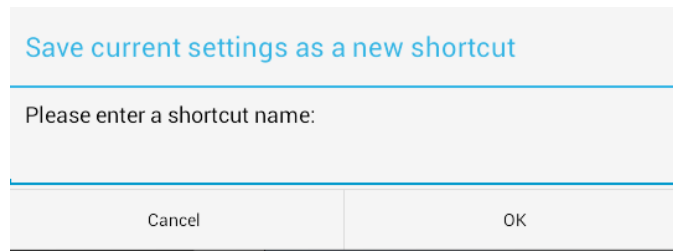

7. Enter your shortcut name and tap [**OK**]. For example, bess. The new shortcut button will be displayed on the LCD Touch Panel.

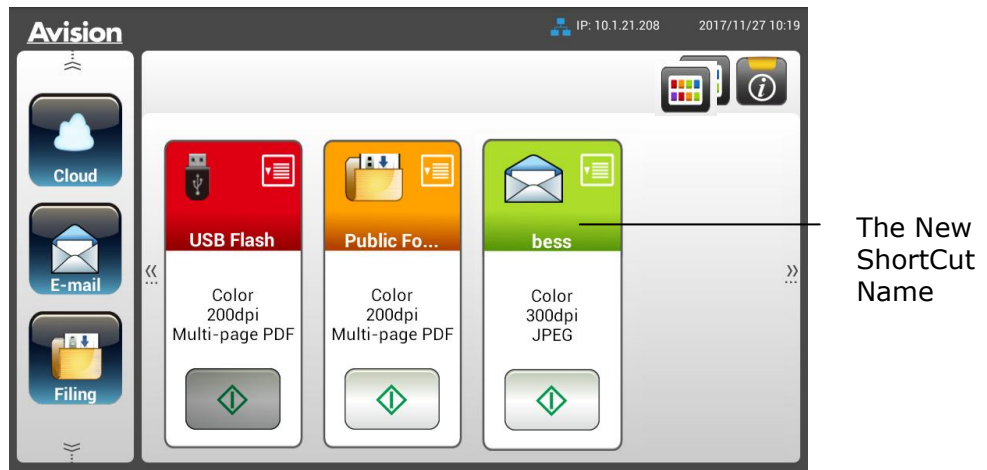

Note:

Follow the similar procedure to create your frequently Cloud or Filing destination to be your ShortCut on the LCD Touch Panel.

Using the Shortcut Buttons

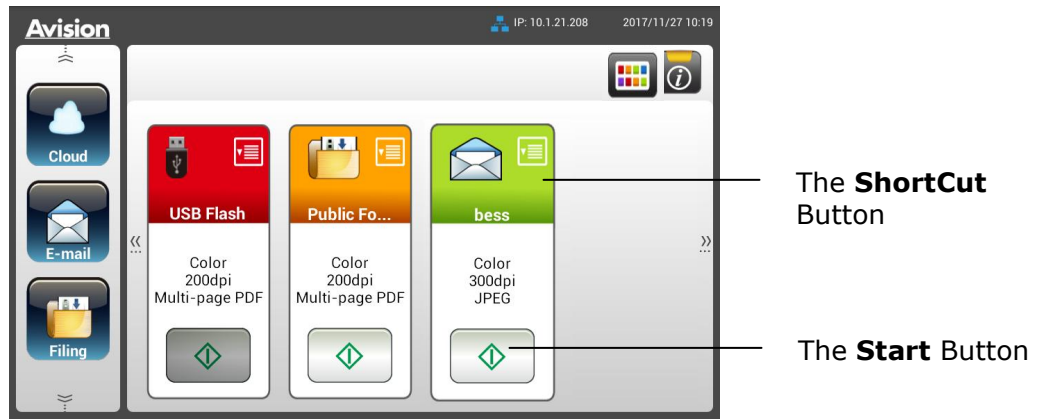

To use a Shortcut button,

1. Tap the [**Start**] button of your desired ShortCut button on the touch screen.



2. The scanner starts scanning and a preview image will be displayed.
3. On the Preview screen,



- **Start:** If the scanned image is OK, press the [**Start**] button () on the touch panel to distribute the scanned image.
- **Remove:** If the scanned image is not satisfactory, tap the [**Remove**] button () to delete the scanned image.
- **Insert:** You may also insert more pages by taping the [**Insert**] () button.
- **Cancel:** If the scanned image is not OK, tap the [**Cancel**] button to abort the job.

4. The scanned images are sent to your specified destination.

Scanning and Broadcasting Your Images

The Scancast (Scan and broadcast) feature allows you to scan a document first and then send to many destinations respectively.

Basic Operation

Using the Default Settings

1. Load your document in the ADF with the 1st page facing down and the top of the pages pointing to the feeder.





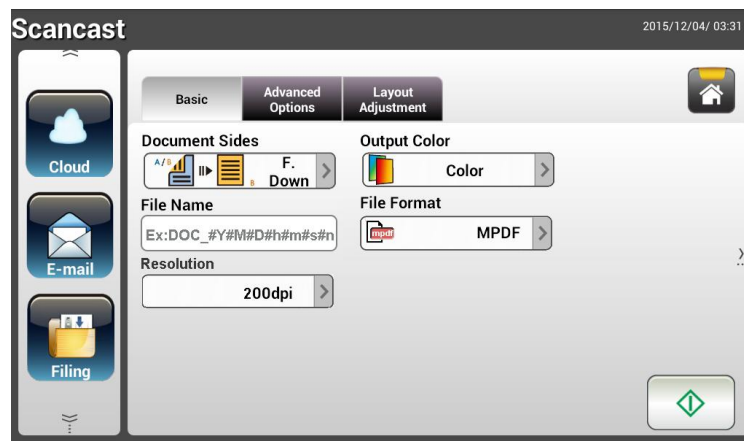

2. Press the **Scancast** button on the touch screen. The following **Scancast** main screen will be displayed.



3. If desired, enter the file name prefix in the [**File Name**] field for the scanned document.
4. Check if the document side, output color, or file format meets your requirements. If not, change the settings to suit your needs.
5. Tap the [**Start**] () button. The scanner starts scanning your document.
6. The product starts scanning and the preview image will be displayed.



7. On the Preview screen,
 - **Start:** If the scanned image is OK, press the [**Start**] button () on the touch panel to distribute the scanned image.
 - **Remove:** If the scanned image is not satisfactory, tap the [**Remove**] button () to delete the scanned image.
 - **Insert:** You may also insert more pages by taping the [**Insert**] () button.
 - **Cancel:** If the scanned image is not OK, tap the [**Cancel**] button () to abort the job.

8. If the [**Start**] () button has been selected, the [**Scancast**] window for multiple destinations appears.



9. Choose a [**Cast To**] destination for your scanned image. Choice: Cloud, E-mail, Filing.
 - **Cloud:** Choose your desired cloud servers from a selection of Evernote, and Google Drive.
 - **E-mail:** Enter [To/From] E-mail address.
 - **Filing:** Choose your network folder from a selection of Local or Network. If **Network** is selected, the available network servers will be displayed at the right box. You may use the **Up-arrow** or **Down-arrow** button to scroll from the list.

If **Local** is selected, **USB** and **Public Folder** will be displayed at the right box. If **USB** is selected, make sure a USB flash drive has been inserted to the USB flash drive port of the product.

If **Public Folder** is selected, the scanned image will be stored in the product's memory. Enter the PIN number (folder name) during scanning and then access the scanned image via the product's embedded web page. (Refer more detailed information on subsequent section - Customizing the Product's Settings via the Embedded Web Page.)

10. After your first destination has been specified, press the [**Start**] () button to send the scanned image to the destination.
12. After the scanned image has been delivered successfully to your first destination, the [**Scancast**] window for multiple destinations appears again.



13. Repeat Step 9 to choose your 2nd destination and then press the [**Start**] () button to send the scanned image to the destination.
14. Repeat Step 12 ~ Step 13 to send the scanned image to another destination.
15. If you have finished distributing your scanned image to all the destinations you want, press the [**Back**] button to exit the screen.

Advanced Operation

Using Special Settings

1. Load your document in the ADF with the 1st page facing down and the top of the pages pointing to the feeder.





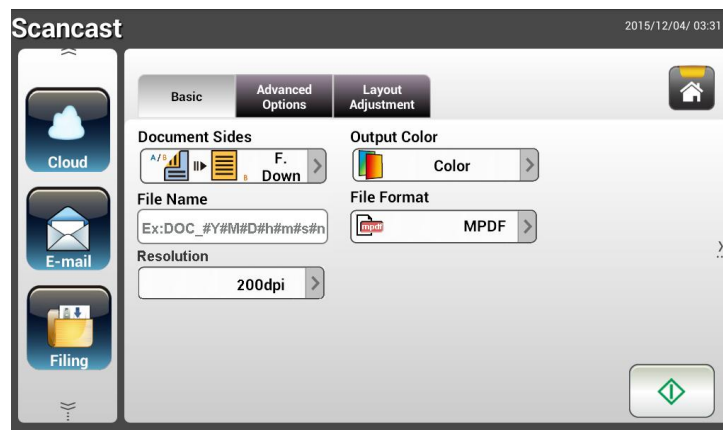

2. Press the **Scancast** button on the touch screen. The LCD Touch Panel prompts the following **Scancast** main screen.

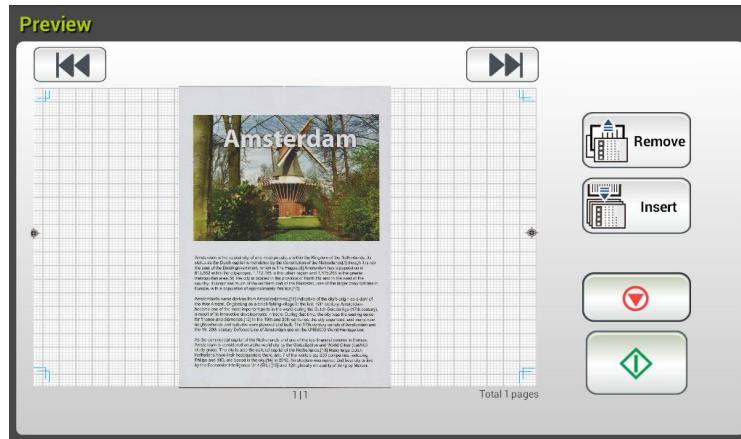

3. On the **Basic** screen, enter your desired file name and check if document side, output color, or file format meets your requirements. If not, change the settings to suit your needs.
4. Tap the **Advanced Settings** tab to prompt the **Advanced Settings** screen. Change the density, contract, resolution, and quality level if the default settings are not satisfactory. (For more information about the scan settings, please refer to the preceding section – Scanning and Sending Your Documents to E-mail Addresses on page 31.)
5. Tap the **Layout Adjustment** tab to prompt the **Layout Adjustment** screen. Change original size and preview if the default settings are not satisfactory. (For more information about the scan settings, please refer to the preceding section – Scanning and Sending Your Documents to E-mail Addresses on page 33.)
6. Tap the **Start**  button. The scanner starts scanning your document.
7. The product starts scanning and the preview image will be displayed.



8. On the Preview screen,
- **Start:** If the scanned image is OK, press the [**Start**] button () on the touch panel to distribute the scanned image.
 - **Remove:** If the scanned image is not satisfactory, tap the [**Remove**] button () to delete the scanned image.
 - **Insert:** You may also insert more pages by taping the [**Insert Pages**] button () on the bottom of the screen.
 - **Cancel:** If the scanned image is not OK, tap the [**Cancel**] button () to abort the job.

9. If the [**Start**] () button has been selected, the [**Scancast**] window for multiple destinations appears.

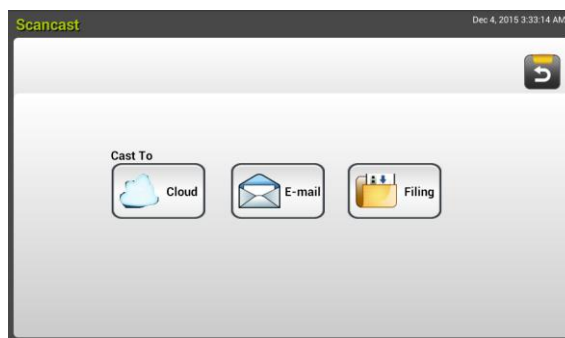

10. Choose a [**Cast To**] destination for your scanned image. Choice: Cloud, E-mail, Filing.
- **Cloud:** Choose your desired cloud servers from a selection of Evernote, and Google Drive.
 - **E-mail:** Enter [To/From] E-mail address.
 - **Filing:** Choose your network folder from a selection of Local or Network. If **Network** is selected, the available network servers will be displayed at the right box. You may use the **Up-arrow** or **Down-arrow** button to scroll from the list.

If **Local** is selected, **USB** and **Public Folder** will be displayed at the right box. If USB is selected, make sure a USB flash drive has been inserted to the USB flash drive port of the product.

If **Public Folder** is selected, the scanned image will be stored in the product's memory. Enter the PIN number (folder name) during scanning and then access the scanned image via the product's embedded web page. (Refer more detailed information on subsequent section - Customizing the Product's Settings via the Embedded Web Page.)

11. After your first destination has been specified, press the [**Start**]

() button to send the scanned image to the destination.

12. After the scanned image has been delivered successfully to your first destination, the [**Scancast**] window for multiple destinations appears again.



13. Repeat Step 10 to choose your 2nd destination and then press the [**Start**]

() button to send the scanned image to the destination.

14. Repeat Step 12 ~ Step 13 to send the scanned image to another destination.

15. If you have finished distributing your scanned image to all the destinations you want, press the [**Back**]

4 Setting Up and Managing Destinations

This section provides procedure for the administrator to setup and manage your destinations including E-mail addresses or network folders to distribute the scanned document on the network.

Setting Up Your E-mail Address Book

This section provides procedure for the administrator on how to setup E-mail Address Book. The address book can be setup and managed either through the LCD Touch Panel or the product's embedded web page. This section uses LCD Touch Panel as an example.

Adding a new E-mail Address

Follow these steps to add a new E-mail address.

1. On the Home screen of the LCD Touch Panel, select [**Settings**] > [**Address Book**] in succession. The E-mail Address Book screen will be displayed.



2. Tap [**New**] to prompt the [**New E-mail Address**] page.



3. Enter your E-mail address and its description.
4. Tap [**Save**] to save your address and leave the E-mail screen.

Note:

Up to 200 E-mail addresses can be entered in the Address Book.

Editing a Current E-mail Address

To modify a current E-mail address,

1. Repeat Step 1 from the previous section, *Adding a New E-mail Address*. The [**E-mail Address Book**] page will be displayed.
2. Select the E-mail address which you want to modify from the list and then tap [**Edit**] to prompt the [**Modify E-mail Addresses**] page.
3. Modify your address information.
4. Tap [**Save**] to save the setting and leave the E-mail screen. Or tap [**Cancel**] to leave the page without saving any setting.

Deleting a Current E-mail Address

To delete a current E-mail address,

1. Repeat Step 1 from the previous section, *Adding a New E-mail Address*. The [**E-mail Address Book**] page will be displayed.
2. Choose the address you want to delete from the list and then choose [**Delete**] to erase the address. A Confirmation dialog box appears to confirm your deletion. Click [**OK**] to confirm or [**Cancel**] to exit.

Adding a new E-mail Group

To send multiple addresses simultaneously at one time, you can create address group to speed up the process. Up to 50 addresses can be included in one group and a total of 50 groups can be created in the Address Book.

To add a new E-mail group,

1. Repeat Step 1 from the previous section, *Adding a New E-mail Address*. The **[E-mail Address Book]** page will be displayed.
2. Tap **[Group]** and then choose **[New]** to prompt the **[Add a New Group]** page.
3. Enter your group name and its description.
4. Choose the address from the address list and click → to add a member to the group.

Settings >> Address Book >> Group 2016/11/16/ 09:07

Cancel Save

Name Description

Edit Members

Contacts List Group Members

AV01419	tina_yang@abc.com	
AV01420	irene_tseng@abc.co	
AV01426	jerry_chang@abc.co	12
AV01445	steven_hsiung@abc	

0

5. Click **[Save]** to save the setting or **[Cancel]** to leave the page without saving any setting.

Editing a Current E-mail Group

To modify a current E-mail group,

1. Repeat Step 1 from the previous section, *Adding a New E-mail Address*. The [**E-mail Address Book**] page will be displayed.
2. Tap [**Group**] and choose the group which you want to modify from the list and then tap [**Modify**] to prompt the [**Modify E-mail Group**] page.
3. Modify your group information. Choose the group member you wish to add and then click → to add the new member or click ← to delete an old member from the group.
4. Tap [**Save**] to save the setting and leave the E-mail screen. Or tap [**Cancel**] to leave the page without saving any setting.

Deleting a Current E-mail Group

To delete a current E-mail group,

1. Repeat Step 1 from the previous section, *Adding a New E-mail Address*. The [**E-mail Address Book**] page will be displayed.
2. Tap [**Group**] and choose the group which you want to delete from the list and then tap [**Delete**] to erase the group.
3. A Confirmation dialog box appears to confirm your deletion. Click [**OK**] to confirm or [**Cancel**] to exit.

Setting Up Your Filing Profiles

The section provides procedure on how to setup your Filing Profiles to send your scanned document to a specified network folder. The Filing Profiles can be setup and managed either through the LCD Touch Panel or the product's embedded web page.

Adding a new Filing Profiles

To create a Filing Profiles, follow these steps:

1. On the Home screen of the LCD Touch Panel, select [**Settings**] > [**Filing Profiles**] in succession. The Filing Profiles screen will be displayed.



2. Tap [**New**] to prompt the [**New Filing Profiles**] page.
3. Enter your Filing Profiles information. Refer to the preceding section, **Creating Your Filing Profile** (page 19), on how to enter your folder information.
4. Tap [**Save**] to save your setting or [**Cancel**] to leave the screen without saving these settings.

Editing a Current Filing Profiles

To modify a current Filing Profiles,

1. Repeat Step 1 from the previous section, *Adding a New Filing Profiles*. The [**Filing Profiles**] page will be displayed.
2. Choose the Filing Profiles which you want to modify from the list and then tap [**Modify**] to prompt the [**Modify Filing Profiles**] page.
3. Modify your folder information.
4. Tap [**Save**] to save the setting and leave the Filing Profiles screen. Or tap [**Cancel**] to leave the page without saving any setting.

Deleting a Current Filing Profiles

To delete a current Filing Profiles,

1. Repeat Step 1 from the previous section, *Adding a New Filing Profiles*. The [**Filing Profiles**] page will be displayed.
2. Choose the folder you want to delete from the list and then choose [**Delete**] to erase the folder. A Confirmation dialog box appears to confirm your deletion. Click [**OK**] to confirm or [**Cancel**] to exit.

5 Starting a Scan from Your Mobile Device

With a built-in Wi-Fi module, the scanner is converted into a wireless device. When a mobile device is use, the scanned images can be received from the mobile device.

Making Preparation

To connect the scanner to a wireless LAN, prepare the followings:

- **An environment in which a wireless LAN is available**

When connecting the scanner to a wireless LAN, you may need information for a wireless access point such as an SSID (network name) and a security key (password). For details, contact your Network Administrator or refer to the manual for the wireless access point.



Attention!

Do not place obstacles that block radio waves (e.g. walls or metal plates) or devices that cause radio wave interference (e.g. cordless phones) within 100 mm of the scanner, or near your wireless access point.

- **MB Application**

Download the **MB Application** on your mobile device from an application store such as Google Play.

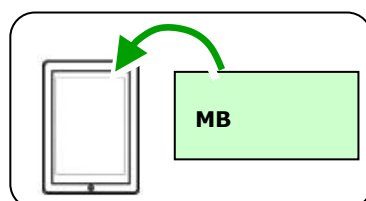

Connecting to A Wireless Network

Connecting to a Wi-Fi network in an AP (Access Point) Mode

In AP (Access Point) mode, your mobile devices and the scanner are connected wirelessly without an additional AP (Access Point) since the scanner itself works as an AP.

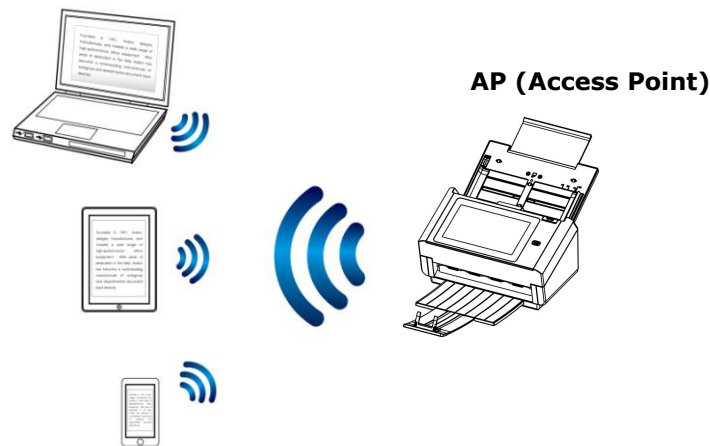

1. If you have connected a wired Ethernet cable to the scanner, disconnect the network cable.
2. On the Home Screen of the LCD Touch Panel, tap [**AP Mode**]. In a second, the SSID and IP Address will be displayed.



3. On your mobile devices, make sure Avison-xxxxxx (xxxxxx indicates the last six digits of the Mac Address) has been selected as your network name (SSID).

Connecting the Scanner to a Wi-Fi Network in a Client Mode

In a Client mode, your mobile devices and scanner are connected wirelessly through an additional AP (Access Point). This mode is also the default wireless mode.

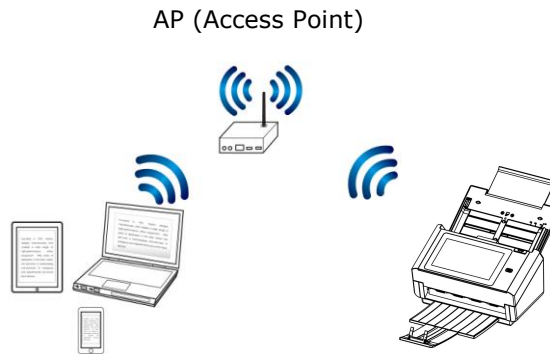

Connecting Your Scanner to an Access Point:

Important:

Note the wired and wireless mode can not work at the same time. To connect the scanner in a wireless network, please first disconnect the Ethernet cable connecting to your scanner.

1. If you have connected a wired Ethernet cable to the scanner, disconnect the network cable.
2. On the Home Screen of the LCD Touch Panel, tap [**Settings**] > [**Network**]. Make sure that [**Wireless Client**] is turned on.

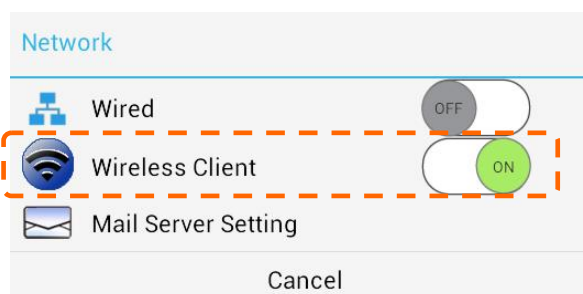

3. In a second, current wireless networks near you will be displayed as shown below.



5. Select an Access Point and click [**Connect**] to connect the scanner to a specified Access Point, for example, SMCWBR14S-NL. In a few seconds, if the connection is successful, the IP address and Mac address of the scanner will be displayed as indicated above.

Note:

If your access point is set to not broadcast the SSID, please follow these steps to manually add the SSID name (network name):

1. On the wireless page, tap the [**More Settings**]> button and then choose [**Add network**]. The [**Add network**] page will be displayed.

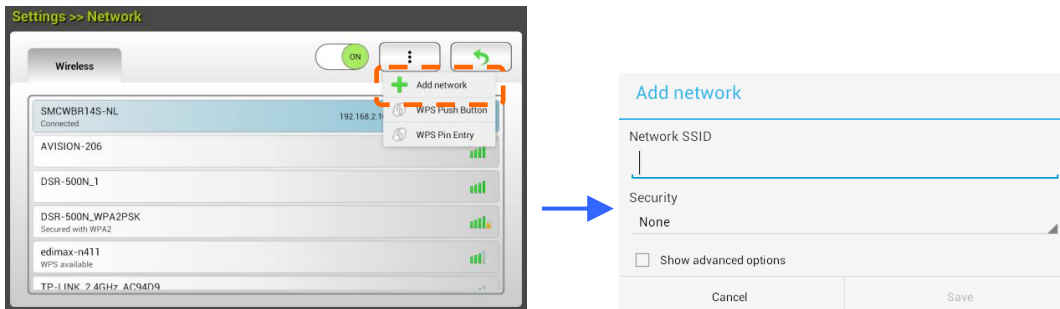

2. Enter the Network SSID name and choose the security mode, encryption type, and network key and then tap [**Save**] to search the wireless network manually.

Your scanner supports the following authentication methods:

Security mode	Encryption method	Key Index
WPAPSK	TKIP, AES, TKIPAES	X
WPA2PSK	TKIP, AES, TKIPAES	X

Connecting to a Wireless Access Point Using the WPS Button

You may connect the scanner to a WPS compatible wireless access point by pressing the WPS button on the back of the scanner.

Before You Begin!

To enable the WPS connection of your access point, please refer to the user's guide of your access point.

Perform the following procedure to connect.

1. Confirm your wireless access point/router has the WPS or AOSS™ symbol as shown below.



2. Press the WPS button of your wireless access point. (You may refer to the user's guide of your access point/router for instructions on how to use the WPS button.)

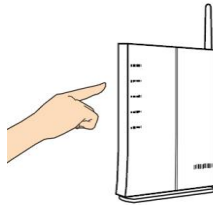

3. On the wireless page, tap the [**More Settings**] > button and then choose [**WPS Push Button**] for at least 2 minutes.



4. If the connection is successful, the connected AP name will be displayed on the page as indicated below.

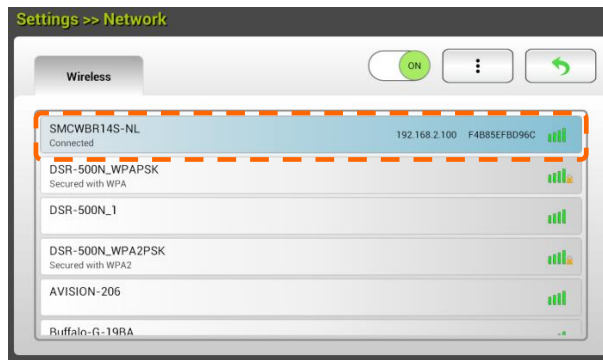

Scanning a Document from a Mobile Device

Make sure that the **MB Application** (Scan App) has been installed on your mobile device. The **MB Application** can be purchased for free from an application store such as Google Play.

1. Enable **[Wi-Fi]** from **[Settings]** of your wireless computer, smartphone, or tablet and then choose the same network name (SSID) of your scanner. For example, SMCWBR14S-NL.

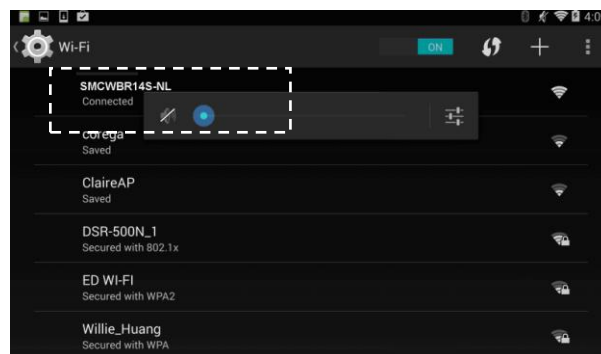

2. Tap the **MB** app () on the screen to launch the Scan Application. The main window will be displayed and the application will automatically search a scanner in the same wireless LAN. If successful, **[Start scan]** will be displayed at the bottom as shown below.

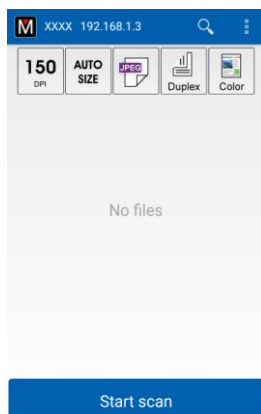





ATTENTION:

If the scanner is not found, please check the followings:

1. The scanner is not ready yet. Tap **[More Settings]** and then **[Search scanner]** to search the scanner again.
2. Check if the mobile device and the scanner are in the same wireless LAN.

3. Check if the default settings meet your requirements. If not, change the scan settings to fit your specific scanning task.

Item	Description
	Resolution: Select your desired resolution. The higher resolution, the greater the image quality and disk space. Choice: *150, 200, 300 dpi
	Scan Size: Select your paper size or you may choose Auto to let the scanner detect your document size automatically. Choice: *Auto size, A4, LTR (Letter), LGL (Legal), 4x6, 5x7
	File Format: Select the file format for your image. Choice: *JPEG, PDF, TIFF Note: <ul style="list-style-type: none"> • The JPEG file does not support the B&W image. • The TIFF file format supports only the B&W image.
	Select to scan the front side (simplex) or both the front side and the rear side (duplex) of your document. Choice: *Simplex, Duplex Note: The duplex mode is available to scan from the auto document feeder only.
	Color Mode: Select your desired image mode. Choice: *Color, B&W, Gray
* Default settings	

4. Load a page to the auto document or place a page on the flat bed.
5. Tap the [**Start scan**] button. (Choose your scanner if there is more than one scanner connected to the network). In a second, the scanner begins scanning the document and the thumbnail scanned image will be displayed.

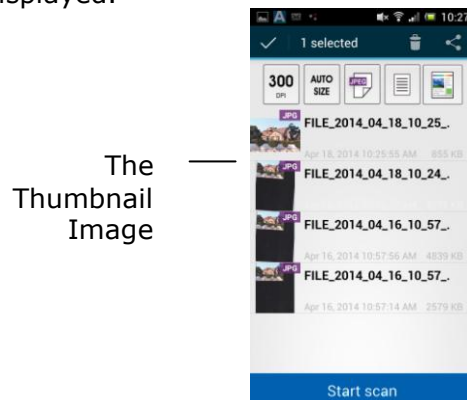

6. Tap the thumbnail image to view the entire image.

6 Customizing the Product's Configurations

This chapter is specifically targeted to the persons who are responsible for the administration of the product. It is recommended that the administrator read this chapter before installing the machine.

The product's configurations can be customized via the LCD Touch Panel. In addition to using the touch screen, the product allows the administrator to remotely configure the machine by launching the product's embedded web page. How to customize the product's configurations via these two methods will be described in the following sections.



Note:

When installing the product for the first time, it is recommended that the Administrator retain the default system settings. The settings can be customized at a later date once you are familiar with the operation and functionality.

Customizing the Product's Configurations by the Touch Screen

Press the **[Settings]** button on Touch Screen. Please login with the default user name and password – [admin]. The **[Settings]** screen will be displayed as indicated. (The password can be changed later in the web page.)



These 8 buttons displaying at the top are: General, Network, E-mail Default, Filing Default, Filing Profiles, Address Book, ShortCut, and Service Mode. For details on each setting, please refer to the subsequent section, Summary of the Product's Configurations.

Customizing the Product's Configurations by the Product's Web Page

1. Open your browser.
2. Type the IP address of the product in the URL field of your browser and then press Enter. The product's embedded web page appears.



3. To access complete information of the web page, please login with the default user name and password – [admin]. The password can be changed later in the web page.

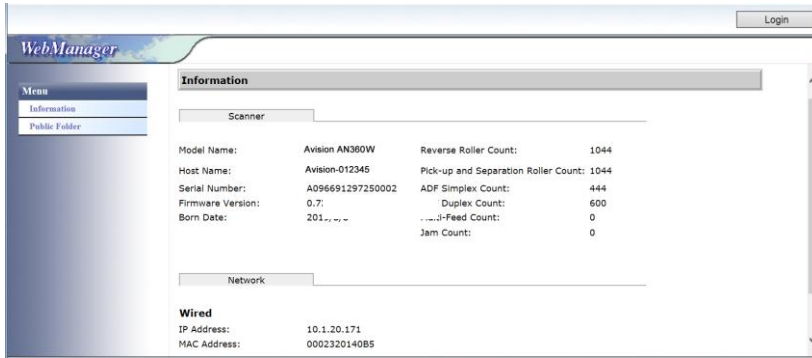

Click each item under these tabs to set up relevant values. For details on each setting, please refer to the subsequent section, Summary of the Product's Configurations.

Summary of the Product's Configurations

Information: Used to show the product's basic information.

Scanner	
Items	Description
Model Name	Used to show the product's model name.
Host Name	Used to show the product's host name (Avision-xxxxxx) for the scanner in a wired and wireless environment. Xxxxxx indicates the last six digits of the scanner's Mac address.
Serial Number	Used to show the product's current time. The time format is 24-hour system.
Firmware Version	Used to show the firmware version.
Born Date	Used to show the manufacturing date.
Scan Count	Scan Count including Reverse Roller Count, Pick-up and Separation Roller Count, ADF Simplex Count, Multi-Feed Count, and Paper Jam Count. Reset Roller Count: Click this button to reset roller count after roller has been replaced.
Network	
Items	Description
Wired	Used to show the product's IP and Mac address in a wired network environment.
Wireless AP	Used to show the IP and Mac address of the product's AP (Access Point) in a wireless network environment.
AP Mode	Used to show the product's SSID (network name) and IP address in a wireless network environment.

Device Management

General: Used to specify the product's general information.

General	
Items	Description
Host Name	Avision-xxxxxx: The network name (SSID) for the scanner in a wired and wireless environment. Xxxxxx indicates the last six digits of the scanner's Mac address.
NTP Server	Used to specify the product's NTP server.
Date	Used to specify the product's current date.
Time	Used to specify the product's current time. The time format is 24-hour system.
Time Zone	Used to specify the time zone of your location.
Power Saving	Used to specify the length of time the product needs to enter the power saving mode after last action. Range: 1 ~ *240 minutes
Keep wired network on during sleeping	Check to keep wired network on during the machine's power saving mode.
Enable Auto Power Off	Check to enable auto power off. Range: *0 ~ 480 minutes
Screen Off	Enter the length of time the product turns off the screen after the last action. Choice: *Never, 3 min, 5 min, 10 min
Device E-mail Address	Enter device's e-mail address. This address serves as [Report to E-mail] address in Filing function if you wish to send the filing report to an E-mail address.
Multi-Feed Detection default	Choose if you wish to enable the Multi-Feed Detection via ultrasonic unit. Ultrasonic Detection allows you to set overlapped document by detecting paper thickness between documents. Choice: On/*Off
Admin Profile	Used to specify the login name and password to enter the product's web page. E-mail Address: used to specify the administrator's E-mail address.
Function Lock	
Scan to USB	Used to enable or disable the function. Choice: *ON/OFF
A+ Manager Settings	
A+ Manager Settings	Check [Enable] and then enter the IP address of a specified server to send the system log file to for quick troubleshooting.
* : Factory Default	

Network: Used to specify the product's network settings.

Items	Description								
Wired									
DHCP	Used to specify if the product's IP address is assigned by DHCP or a static IP. Choice: Off, On If you have a DHCP server available on your network and the DHCP has been enabled, the IP address, subnet mask, gateway, and DNS server will be automatically given.								
	<table border="1"> <tr> <td>IP Address</td> <td>The Internet Protocol (IP) address assigned to your machine by your network administrator.</td> </tr> <tr> <td>Subnet Mask</td> <td>The net mask address assigned by your network administrator.</td> </tr> <tr> <td>Gateway IP</td> <td>The gateway IP address assigned by your network administrator.</td> </tr> <tr> <td>DNS Server</td> <td>The Domain Name Server assigned by your network administrator.</td> </tr> </table>	IP Address	The Internet Protocol (IP) address assigned to your machine by your network administrator.	Subnet Mask	The net mask address assigned by your network administrator.	Gateway IP	The gateway IP address assigned by your network administrator.	DNS Server	The Domain Name Server assigned by your network administrator.
	IP Address	The Internet Protocol (IP) address assigned to your machine by your network administrator.							
	Subnet Mask	The net mask address assigned by your network administrator.							
	Gateway IP	The gateway IP address assigned by your network administrator.							
DNS Server	The Domain Name Server assigned by your network administrator.								
Mail Server									
Items	Description								
Mail Server	Enter the IP address of your SMTP server (mail server).								
SMTP Port #	Enter the port number of the SMTP server. * 25								
Authentication Method	Choose to enable the email authentication method. Choice: OFF, *ON								
Encrypt	Choose the encryption method of your emails to the SMTP server. Choice: *None, STARTTLS, SSL/TLS								
Login Name	Enter the login name for SMTP authentication.								
Password	Enter the login name for SMTP authentication.								

LDAP Settings	
Items	Description
Authentication LDAP	Enter the IP address of your LDAP server and its port number.
New	Setup a new LDAP setting. Enter IP address and port number of your LDAP server, Login name and password to access the LDAP server, and search information. Note: Check LDAP server information with your Network Administrator.
Delete	Delete a current LDAP setting.
Modify	Modify information of a current LDAP setting.
* : Factory Default	

E-mail Default: Used to specify the product's default scan settings for E-mail. The default scan settings include 5 tabs which are Basic, E-mail Option, Advanced Settings, Layout Adjustment. For more details on the options of each tab, please refer to the setting description on the preceding section, Scanning and Sending Your Documents to E-mail Addresses on page 30.

Filing Default: Used to specify the product's default scan settings for Filing. The default scan settings include 5 tabs which are Basic, E-mail Option, Advanced Settings, Layout Adjustment. For more details on the options of each tab, please refer to the setting description on the preceding section, Scanning and Sending Your Documents to a Network Folder, a USB Flash drive or a Public Folder on page 35.

Filing Profiles: Used to setup and manage your file destinations including FTP, SMB, USB (an inserted USB flash drive), or a Public Folder (the machine’s memory).

Items	Description
Add	Add a new Filing Profiles. Enter information on the [Basic], [Advanced Settings], [Layout Adjustment] tabs. For more details on the options of each tab, please refer to the setting description on the preceding section, Scanning and Sending Your Documents to a Network Folder, a USB Flash drive or a Public Folder on page 35.
Delete	Delete a current profile.
Modify	Modify a current profile.
Folder Name	Used to specify the folder name for the destination.

Address Book: Used to create or edit your address book. Options include Add, Modify, Delete, and Group.

ShortCut: Used to set up the product’s ShortCut displayed on the LCD touch panel.

Item	Description
Destination	Choice: USB Flash, Public Folder, FTP, FTPS, SMB, E-mail. Option: New, Edit, Delete

Account Management: Used to define users and set user's privileges including using the copy, E-mail, cloud, or filing function of the product by assigning an account's authentication method.

Basic	
Items	Description
Enable Security Management	Check to implement security by setting up accounts and enabling LDAP authentication.
Enable Guest Account	Check to allow guest accounts.
Enable LDAP Authentication	Check to enable LDAP authentication.
Default Enable Function	Check the names of functions (ShortCut, Cloud, E-mail, Filing, BM2 Air, AP Mode, Scancast) to be allowed to perform.
Account List	
Items	Description
New	Setup a new account. Enter User Name, Password, E-mail Address, check the functions to be allowed to perform, and check if using LDAP authentication.
Delete	Delete a current account.
Modify	Modify information of a current account.

Firmware Update: Obtain the latest firmware file from the web site (www.avision.com) first. And then click [**Browse**] to find the file on your computer. Finally click [**Update**] to update the latest firmware to the product.

Configurations Customized Only Via the LCD Touch Screen

There are some activities which can be set only through the LCD touch screen, for example, the service mode. The service mode is set to provide saving system log file, updating firmware for quick troubleshooting your problems.

Accessing the Service Mode

To access the service mode,

1. On the product's LCD screen, choose [**Settings**] and then [**Service Mode**].
2. The Service Mode screen will be displayed with following options: [**FW Updated**], [**Reset to Default**], [**Run-in Test**], and [**Save Log**].

FW Updated:	Follow these steps to update the firmware: <ol style="list-style-type: none">1. Locate the latest firmware file from the web site (http://www.avision.com).2. Store the firmware file on your removable USB disk.3. Plug the removable USB disk into the USB disk port of the machine.4. Tap [FW Updated] to update the firmware file.
Reset to Default:	Choices include [Reset Admin], [Reset Network Settings], [Reset Admin and Network], [Reset to Factory Default]. Reset Admin: Reset the login user name and password of the product's web page. Reset Network Settings: Reset the network settings to factory default. Reset Admin and Network: Reset both the login information and the network settings to default. Reset to Factory Default: Reset all configurations to factory default values.
Run-in Test:	For internal use only.
Save Log:	Plug a removable USB disk into the USB port of the machine and tap [Save Log] to save system log file.

Adjusting Brightness

To adjust brightness on the LCD screen, follow these steps:

1. On the product's LCD screen, choose [**Settings**] and then [**Device Management**].
2. Tap the [**Brightness**] option and move the scroll bar to the right to increase your brightness or to the left to decrease your brightness of the LCD screen.

Selecting Language

To select the language, follow these steps:

1. On the product's LCD screen, choose [**Settings**] and then [**Device Management**].
2. Tap the [**Language**] option and select your language display on the LCD screen. Choice: English, Chinese Traditional, Chinese Simplified, Spanish, Portuguese, and Hebrew.
3. Tap [**Save**] to save the settings.

Configurations Customized Only Via the Product's Web Page

There are some activities which can be set only through the product's web page. For example, some options on [**Device Management**], [**Import/Export**], and [**Public Folder**]. How to use these options will be described in the following sections.

Exporting and Importing System Data

To easily manage several AN360W in the network, the machine provides a useful feature to allow system administrator to export the system data of one AN360W into a file and then import this data to other AN360W in the network.

For example, the address book, Filing Profiles, and default systems settings of one AN360W can be first exported to a file as a backup and then import these files to other AN360W.

Follow the procedure described in below to export and then import your system data.

To export system data,

1. On the product's web page, choose [**Import/Export**].
2. Choose the system data you want to export. Choice: Address Book, Filing Profiles, Settings (Device Management, Account Management, Mail Server/LDAP Server, E-mail Default, Filing Default).
3. Choose [**Export Now**]. The selected system data will be exported into a file. If [**address book**] is selected, an AN360W_addressbook.csv file will be generated. If [**Filing Profiles**] or [**settings**] is selected, an AN360W_profile.json or AN360W_setting will be generated...
4. Save the exported file into your computer as a backup.

To import system data,

1. On the product's web page, choose [**Import/Export**].
2. Choose the system data you want to import. Choice: Address Book, Filing Profiles, Settings (Device Management, Account Management, Mail Server/LDAP Server, E-mail Default, Filing Default).
3. On the Importing option, choose [**Browse**] to locate the system data which you have been previously exported.
4. Choose [**Import Now**] to start importing the system data to your machine. The current system data will be overwritten.

Accessing the Public Folder

The machine allows you to save the scanned image temporarily to the product's memory and then access the scanned image through the product's web page. To access the scanned image, follow these steps:

To access the scanned image,

1. On the product's web page, choose [**Public Folder**].
2. A Pin number dialog box appears. If desired, enter your pin number to access the public folder.
3. Choose your scanned file on the [**Public Folder**] and click [**Download**] to download the file to your computer.

Note: The scanned images can be saved on the product's memory for 24 hours only. After 24 hours, the image files will be automatically deleted.

7 Using the Product as a Regular Scanner

Installing the Scanner Driver

NOTE:

- 1).** To ensure your computer can identify the USB scanner, please install scanner driver first before connecting the scanner to your computer.
 - 2).** The scanner driver contains TWAIN, ISIS and WIA driver. After the installation of scanner driver is completed, this scanner allows you to scan via a TWAIN, ISIS, or a WIA interface. Start your TWAIN-compliant image editing software application to select a TWAIN or WIA user interface or your ISIS software to select an ISIS user interface. You may also launch Microsoft's Scanner and Camera Wizard to scan via a WIA user interface.
-

- 1.** Place the supplied CD-ROM onto your CD-ROM drive.
- 2.** The software installation graphic appears. If not, run "**setup.exe**".



Contents on the installation graphic:

- **Install Scanner Driver:** To communicate with your scanner, you need to install the scanner driver.
- **Install Button Manager V2:** To use the [BM2 Air] function, you need to install Button Manager V2. To ensure Button Manager V2 works properly, please FIRST install scanner driver before installing Button Manager V2.
- **Install Virtual Scanner Link:** To connect your computer to the scanner in the network, you need to install the Network Setup Tool.
- **Install AVScan X:** To scan and organize your multi-page document(s), you can install the software application to manage them easily and effectively.

- **View Manual:** Click **“View Manual”** to view or print the detailed user manual for the scanner and Button Manager V2 respectively.
3. Click **Install Scanner Driver** to install the scanner driver and then click **Install Button Manager V2** to install the Button Manager V2 onto your computer.

Connecting to the Computer

Via a USB Cable

1. Connect the **square end** of the USB cable to the USB port of your scanner. Connect the **rectangle end** to the USB port at the rear side of your computer.

Note: The scanner is designed with a USB 3.2 GEN 1X1 interface to ensure the optimal speed. If your computer comes with a USB 3.2 GEN 1X1 port, make sure to connect the scanner to your computer to the USB 3.2 GEN 1X1 port which is distinguished in blue color at the back of your computer. The USB 3.2 GEN 1X1 port enhances your scanning speed and is also compatible with USB 2.0 and USB 1.1.

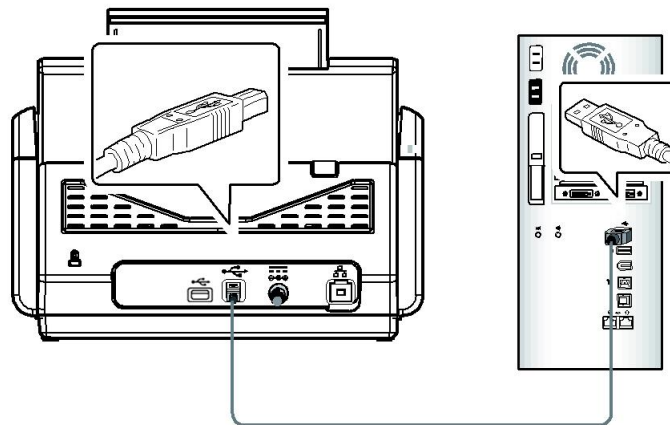

2. The computer should detect a new USB device and prompt a **“New Hardware Found”** message.
3. By following the on-screen instructions, click the **Next** button to continue. When the certification screen appears, click **Continue Anyway** to complete the installation.
4. When the **Finish** dialog is prompted, click the **Finish** button.

Via a Wired Network

1. Connect one end of your Ethernet LAN cable to an available port of your Ethernet Hub.
2. Connect the other end to the port marked  at the back of the product.

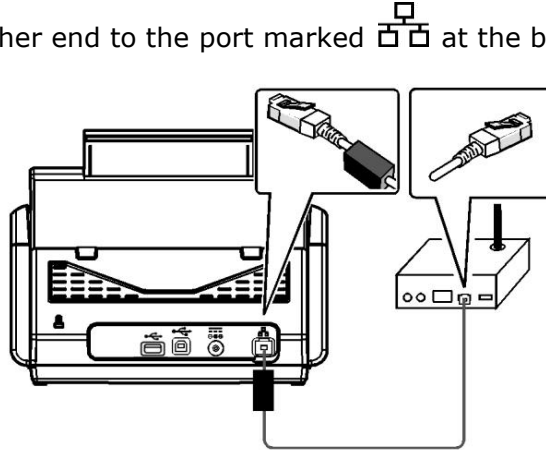

Connecting to the Network Scanner

Before connecting to the network scanner, make sure that Virtual Scanner Link (Network Setup Tool) has been installed onto your computer. The Network Setup Tool is included in the supplied software CD.

1. Start [**Virtual Scanner Link**] by choosing **Start>All Programs>Avison Virtual Scanner>Virtual Scanner Link**. The main window will be displayed and the scanners in your network will be searched automatically. In a few seconds, the result including the scanner model and scanner's IP address will be displayed as shown.

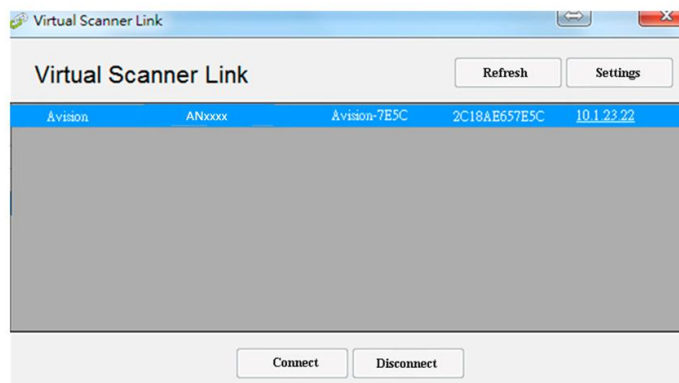

2. Choose the scanner you wish to connect and then press [**Connect**]. If connection is successful, a connection mark will be displayed as shown.

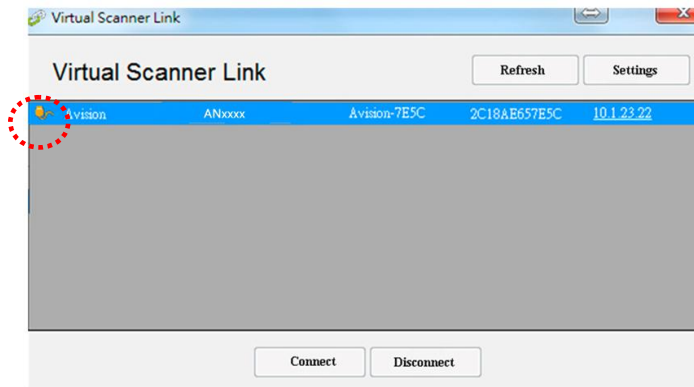

3. After the scanner has been connected successfully, launch your TWAIN-compliant image-editing software application to start a scan.

Note:

- The network scanner can be used by one user at a time. If the network scanner is being used by other user, you will be prompted with a message to connect the scanner later. When the scanner is available, you will also be prompted with a message to connect the scanner and start scanning your document.
- If the network scanner has not been found, it is probably the scanner and your computer are not in the same LAN. In this case, you can assign a specific IP address of the scanner to let [Virtual Scanner Link] automatically search the scanner. Click the [Option] button, type your IP address on the [Searching Address] field **(1)**, then click the [+] button **(2)** and finally click [OK] **(3)** to complete.

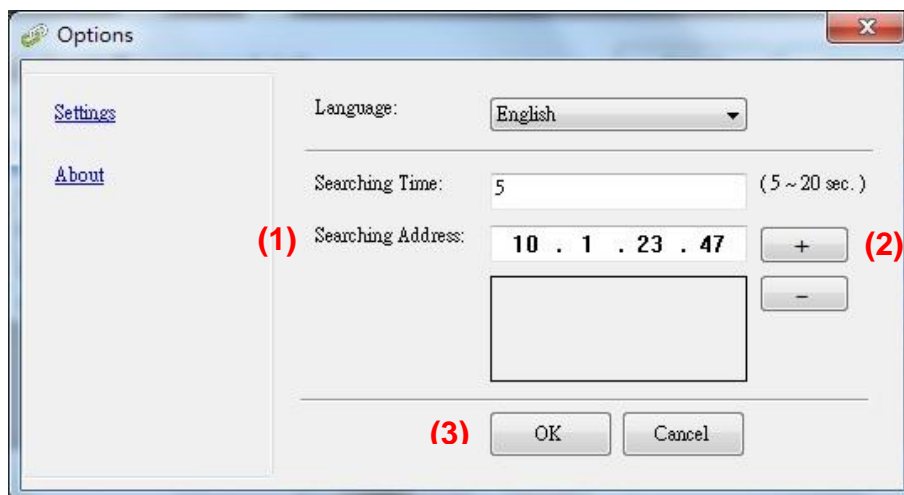

- Searching Time: When the program is launched, it automatically searches the scanner in the network in 5 seconds (default). The searching time can be changed from a range of 5 to 20 seconds.
- If the [Virtual Scanner Link] program has been closed and then launched again, [Virtual Scanner Link] will automatically search and connect the network scanner it has previously connected to.

Verifying Your Scanner Installation

To verify if your scanner installation is correct, Avision provides you a useful test program called Avision Capture Tool. With this tool, you can perform simple scans and view the captured images. In addition, it helps you complete your scan at a rated speed.

The following procedure describes how to verify your scanner installation. If the installation is not correct, please review the preceding section to check if the cable connection and scanner driver have been successfully installed.

Before you begin, be sure the scanner is on.

1. Select Start>Programs>Avision xxx Scanner>Avision Capture Tool. The Select Scanner Model dialog box will be displayed.

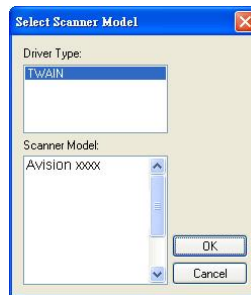

2. Select your driver type and scanner model and click OK. The following Avision Capture Tool dialog box will be displayed.

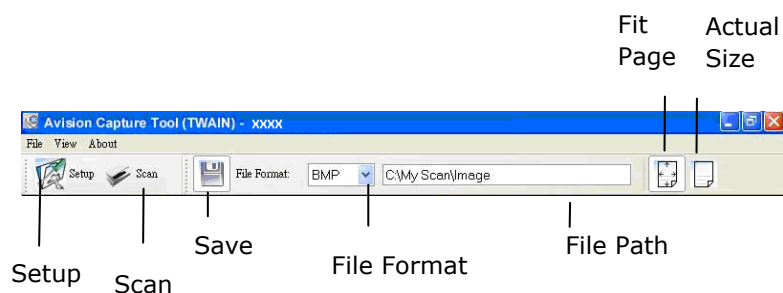

3. Choose your desired file format from the File Format drop down list box. (Default is JPEG, other choice includes TIFF, MTIFF, PDF, MPDF, GIF, and BMP.) The supported file formats vary depending on your scanner model.
4. Type your desired folder name and file name in the File Path box. (Default is C:\Documents and Settings\User Name\My Documents\My Scan\Image.)

Note: If you do not wish to save the scanned image, deselect the Save button since default is Save Enable. In this case, the thumbnail view will be disabled. And therefore, after viewing all the scanned images, only the last one will remain on the screen.



5. Click the Setup button () or choose Setup from the File menu to prompt the Scanner Properties dialog box.

Image Selection Box



6. From the Image Selection Box, choose your desired image type for your scanned image. (Default is Front B&W) If you have a duplex scanner, choose Front and Rear to scan both sides of your document.
7. Click OK to quit the Scanner Properties dialog box. (To learn more details about the Scanner Properties dialog box, please see the subsequent chapter, *Using the Scanner Properties Dialog Box.*)
8. Place your document face down on the document glass or face up in the auto document feeder.
9. In the Scan Validation dialog box, click the Scan button () or choose Scan from the File menu.
10. The document will be scanned and displayed in the Scan Validation screen. After the scanned images have been displayed, your scanner installation verification is completed.

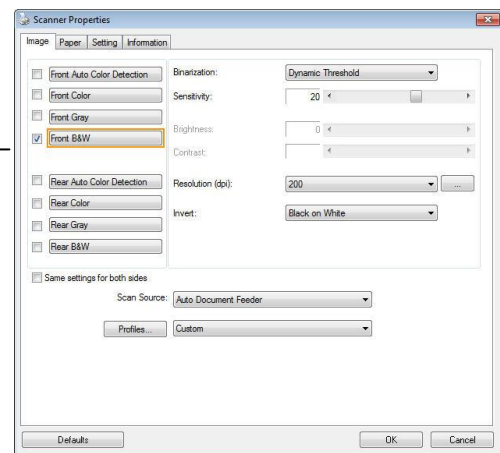
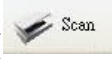
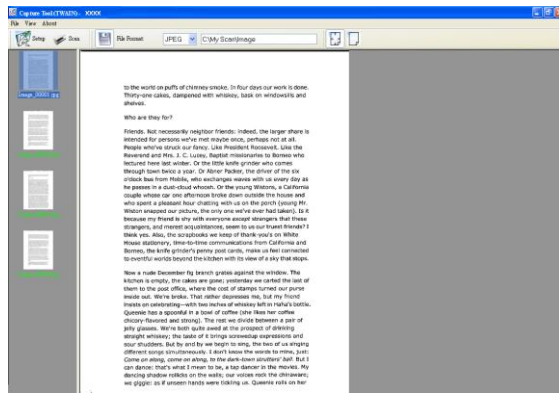

11. You can view the scanned image in Fit Page () or Actual Size (100%) button () from the Viewing toolbars at the right side.
12. Click the Close box or Quit from the File menu to exit the Scan Validation Tool.

A Glance of the Scanner Properties Dialog Box

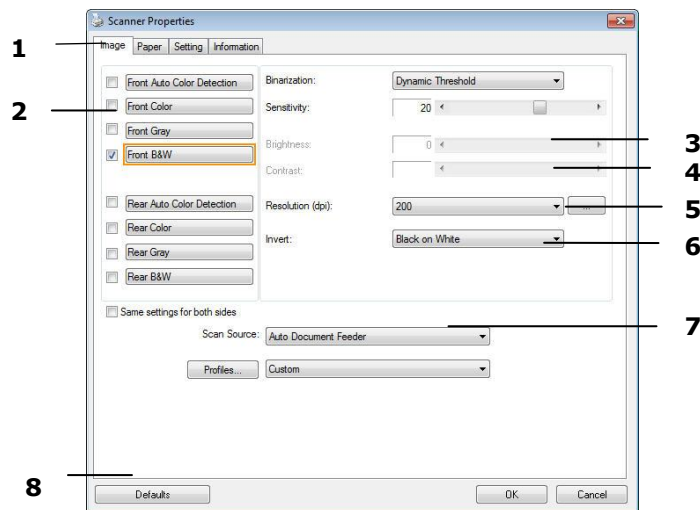

1. Tab Options	Choice: Image, Compression, Color Dropout, Paper, Multi-Feed Detection, Preview, Options, Settings, Information.
2. Image Selection Box	Choose your image type and the side of document you wish to scan. Options vary based on type of scanner.
3. Brightness	Adjust the brightness level from -100 to +100.
4. Contrast	Adjust the contrast level from -100 to +100.
5. Resolution	Determine the quality of the scanned image. The industry standard is 200 dpi.
6. Invert	Reverse the color of your scanned image.
7. Scan Source	Choice: Auto Document Feeder, Flatbed, Flatbed (Book), Automatic (varies due to different scanner model)
8. Defaults	Reset all values on the tabs to the factory default settings.

8 Using the Scanner Properties Dialog Box

The Scanner Properties dialog box allows you to configure the scanner's settings. It consists of several tabbed windows each of which will be described in this chapter.

Note: In this chapter, all options are available based on a duplex (double-side) scanner. If you have purchased a simplex (single-side) scanner, all options are available for single sided only.

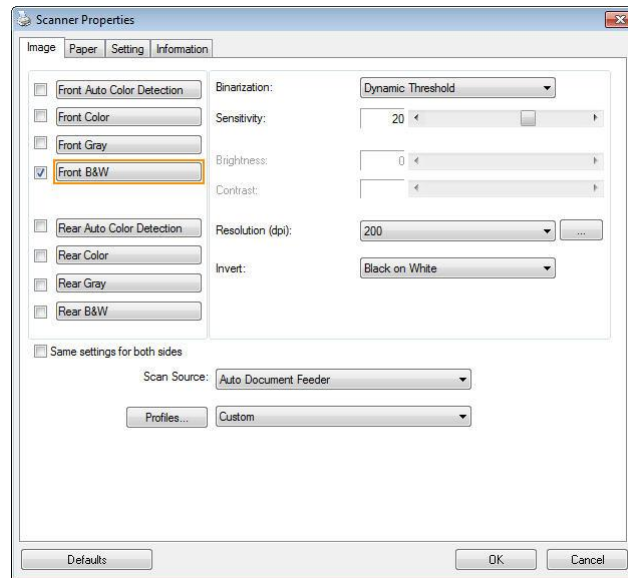

The Scanner Properties dialog box

Buttons on the Scanner Properties Dialog Box

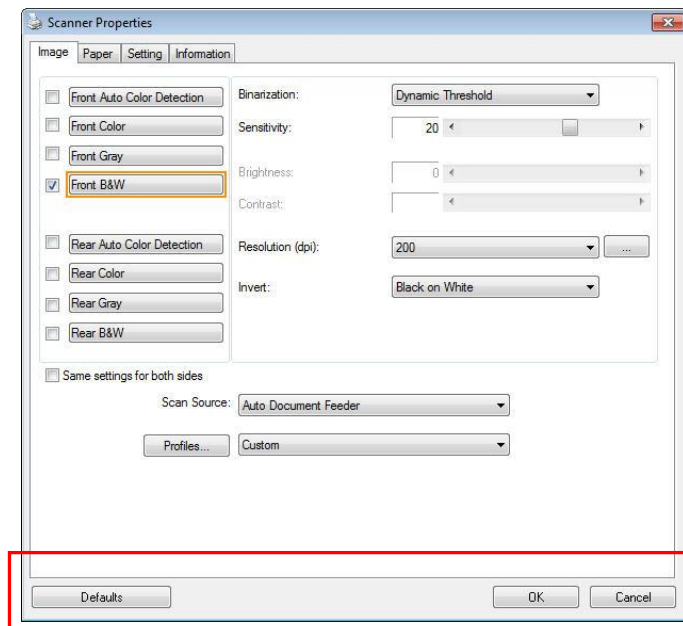

The buttons on the Scanner Properties dialog box

Buttons	Description
Defaults	Click the Defaults button, the factory default settings will be shown on each tab.
Cancel	Click the Cancel button to leave the Scanner Properties dialog box.

The following table shows the default settings :

Tab name	Default settings
Image	Image : Front B&W Binarization : Dynamic Threshold Resolution : 200 dpi Invert : Blank on White Scan Source : Auto Document Feeder Threshold : None Brightness : None Contrast : None
Compression	None
Color Dropout	None
Paper	Cropping : Automatic Deskew : Yes Orientation : Portrait OverScan : 0.00 Note: The availability of this option varies due to scanner model. Unit : Inch
Multi-Feed Detection	None
Preview	None
Options	Rotation Degrees : None Blank Page Removal : None Edge Fill : White , 0 mm Image Control Option : None
Setting	Enable Energy Saver : Enable, 15 minutes after last scan action Show Scanning Progress : Yes Show Warning Message : Yes Save Settings after Closing : Yes
Imprinter	Digital Imprinter

Showing or Hiding Tabs

The [**Scanner Properties**] dialog box is displayed in default with three basic tabs - Image, Paper, and Information. To show more tabs, click the [**Scanner Properties**] icon to access more scan settings.

To show more tabs,

1. Click the [**Scanner Properties**] icon () on the upper left corner, and choose [**Tab**] to show available tab names. The available tabs include Compression, Color Drop out, Preview, Rotation, Separation, Multi-Feed, Options, Settings, and Imprinter. (Note: the options vary based on scanner model.)
2. Choose the tab you want to display. The selected tab will be shown with a check mark and then displayed in the [**Scanner Properties**] dialog box.
3. To access the settings, click the selected tab on the top of the [**Scanner Properties**] dialog box. The page of the selected tab will be displayed.

To hide a tab window,

1. Click the [**Scanner Properties**] icon () on the upper left corner, and choose [**Tabs**] to show available tab names.
2. Choose the tab you want to hide. Then, the selected tab will be hidden in the [**Scanner Properties**] dialog box.

Note: The [**Image**], [**Paper**], and [**Information**] tab can not be hidden since they preprogrammed to be displayed by default.

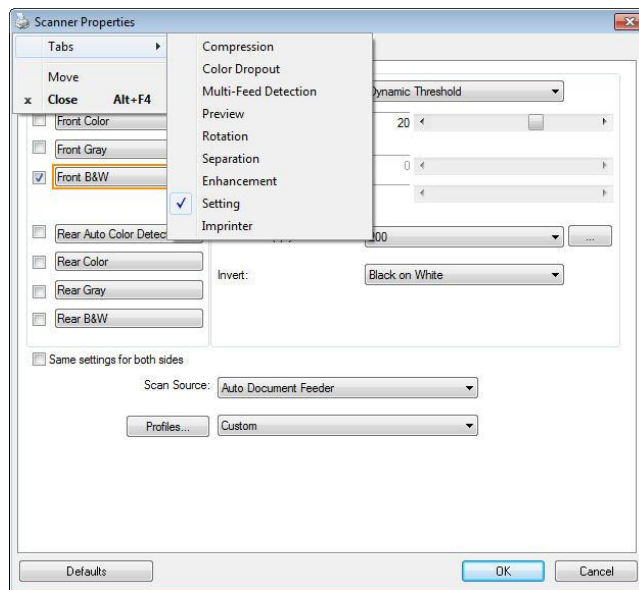

The Image Tab

The Image tab allows you to choose the front side and (or) the rear side of your document, the type of image, and to set several basic scan settings. Note that except for the resolution, you can set individual scan settings for the front side and the rear side. For example, all settings in the Image tab, Compression tab, Color Dropout tab can be set individually for the front and the rear side. However, the settings in the Paper tab, the Option tab, and the Setting tab have to be set the same for the front and rear side.

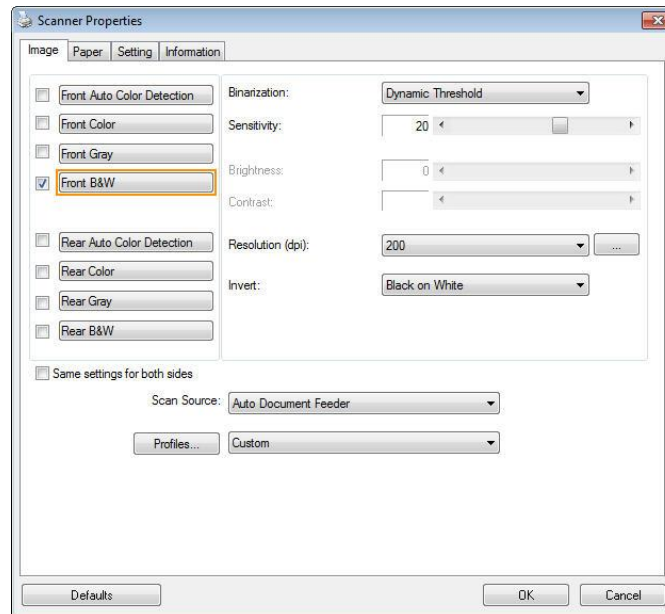

The Image tab dialog box



The Image Selection Box

Front Auto Color Detection
 Front Color
 Front Gray
 Front B&W

 Rear Auto Color Detection
 Rear Color
 Rear Gray
 Rear B&W

The Image Selection box includes the image type and document side option. If you wish to scan both the front side and the rear side of your color document, you can check both Front Color and Rear Color at the same time. Note the options vary based on type of scanner.

Example 1 : Scanning a two-sided color document, both sides in color

<p> <input type="checkbox"/> Front Auto Color Detection <input checked="" type="checkbox"/> Front Color <input type="checkbox"/> Front Gray <input type="checkbox"/> Front B&W <input type="checkbox"/> Rear Auto Color Detection <input checked="" type="checkbox"/> Rear Color <input type="checkbox"/> Rear Gray <input type="checkbox"/> Rear B&W </p> <p>Side/Image Selection</p>	 <p>Front</p>	 <p>Rear</p>
--	---	---

Example 2 : Scanning a two-sided color document, one in B&W, the other in color



<p> <input type="checkbox"/> Front Auto Color Detection <input checked="" type="checkbox"/> Front Color <input type="checkbox"/> Front Gray <input type="checkbox"/> Front B&W <input type="checkbox"/> Rear Auto Color Detection <input type="checkbox"/> Rear Color <input type="checkbox"/> Rear Gray <input checked="" type="checkbox"/> Rear B&W </p> <p>Side/Image Selection</p>	 <p>Front</p>	 <p>Rear</p>
--	---	---

Image Type	Description
Color	Choose Color if you wish to scan a color image for your original in color.
Gray	Choose Gray image if your original contains actual shades of gray.
B&W	Choose B&W if your original contains only text, pencil or ink sketch.



B&W

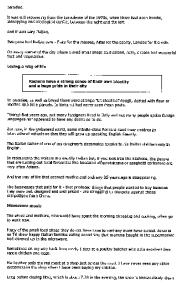

Gray



Color

Front/Rear Auto Color Detection:

Click to automatically detect and scan the front or the rear page of your color document in color image mode. If your document is in colors, the scanner will automatically scan the document into a color image. If your document is non-color, you can choose the output to be either B&W or Gray from the Non-Color Selection option. This option is useful when you have a mixture of color and non-color document.

Note: If you choose Front Rear Auto Color Detection, you can not specify the image mode of your rear page and vice versa.

Modes of Auto Color Detection:

If [Front/Rear Auto Color Detection] is selected, its modes will be displayed. Choice includes **Normal**, **Ignore paper color**. For paper with background color such as invoices, choosing [Ignore paper color] will automatically remove the background color and enhance the detection accuracy.

Normal	Ignore paper color

Sensitivity of Auto Color Detection

If your documents contain primarily B&W text and small amount of light or pale colors and you do not wish them to be recognized as color image to save the file size, you can increase the sensitivity value by moving the bar to the right to let these images to be detected as B&W. The value ranges from 1 to 100. The default is 37.

Standard	IEEE 802.11 b/g/n standards compliant
Wireless LAN	1T1R Mode
Frequency Range	2.400 ~ 2.4835GHz (subject to local regulations)
Number of Selectable Channels	802.11n: 20MHz/40MHz
	USA, Canada (FCC): 11 channels (2.412GHz~2.462GHz)
	802.11b/g: Europe (CE): 13 channels (2.412GHz~2.472GHz)
	Japan (TELECOM): 14 channels (2.412GHz~2.4835GHz)
Data Rate	802.11n: up to 150Mbps
	802.11b: 1, 2, 5.5, 11Mbps
	802.11g: 6, 9, 12, 18, 24, 36, 48, 54Mbps
Transmit Power(EIRP)	11n HT40 MCS7 : +13 dBm
	11g OFDM: +15 dBm
	11b CCK: +18 dBm
Security	WEP 64/128, TKIP, WPA, WPA2 mixed, 802.1x and 802.11i

Original

<table border="1"> <tr> <td>Standard</td> <td>IEEE 802.11 b/g/n standards compliant</td> </tr> <tr> <td>Wireless LAN</td> <td>1T1R Mode</td> </tr> <tr> <td>Frequency Range</td> <td>2.400 ~ 2.4835GHz (subject to local regulations)</td> </tr> <tr> <td rowspan="4">Number of Selectable Channels</td> <td>802.11n: 20MHz/40MHz</td> </tr> <tr> <td>USA, Canada (FCC): 11 channels (2.412GHz~2.462GHz)</td> </tr> <tr> <td>802.11b/g: Europe (CE): 13 channels (2.412GHz~2.472GHz)</td> </tr> <tr> <td>Japan (TELECOM): 14 channels (2.412GHz~2.4835GHz)</td> </tr> <tr> <td rowspan="3">Data Rate</td> <td>802.11n: up to 150Mbps</td> </tr> <tr> <td>802.11b: 1, 2, 5.5, 11Mbps</td> </tr> <tr> <td>802.11g: 6, 9, 12, 18, 24, 36, 48, 54Mbps</td> </tr> <tr> <td rowspan="3">Transmit Power(EIRP)</td> <td>11n HT40 MCS7 : +13 dBm</td> </tr> <tr> <td>11g OFDM: +15 dBm</td> </tr> <tr> <td>11b CCK: +18 dBm</td> </tr> <tr> <td>Security</td> <td>WEP 64/128, TKIP, WPA, WPA2 mixed, 802.1x and 802.11i</td> </tr> </table> <p>Sensitivity: 1 (The image is recognized as a color one)</p>	Standard	IEEE 802.11 b/g/n standards compliant	Wireless LAN	1T1R Mode	Frequency Range	2.400 ~ 2.4835GHz (subject to local regulations)	Number of Selectable Channels	802.11n: 20MHz/40MHz	USA, Canada (FCC): 11 channels (2.412GHz~2.462GHz)	802.11b/g: Europe (CE): 13 channels (2.412GHz~2.472GHz)	Japan (TELECOM): 14 channels (2.412GHz~2.4835GHz)	Data Rate	802.11n: up to 150Mbps	802.11b: 1, 2, 5.5, 11Mbps	802.11g: 6, 9, 12, 18, 24, 36, 48, 54Mbps	Transmit Power(EIRP)	11n HT40 MCS7 : +13 dBm	11g OFDM: +15 dBm	11b CCK: +18 dBm	Security	WEP 64/128, TKIP, WPA, WPA2 mixed, 802.1x and 802.11i	<table border="1"> <tr> <td>Standard</td> <td>IEEE 802.11 b/g/n standards compliant</td> </tr> <tr> <td>Wireless LAN</td> <td>1T1R Mode</td> </tr> <tr> <td>Frequency Range</td> <td>2.400 ~ 2.4835GHz (subject to local regulations)</td> </tr> <tr> <td rowspan="4">Number of Selectable Channels</td> <td>802.11n: 20MHz/40MHz</td> </tr> <tr> <td>USA, Canada (FCC): 11 channels (2.412GHz~2.462GHz)</td> </tr> <tr> <td>802.11b/g: Europe (CE): 13 channels (2.412GHz~2.472GHz)</td> </tr> <tr> <td>Japan (TELECOM): 14 channels (2.412GHz~2.4835GHz)</td> </tr> <tr> <td rowspan="3">Data Rate</td> <td>802.11n: up to 150Mbps</td> </tr> <tr> <td>802.11b: 1, 2, 5.5, 11Mbps</td> </tr> <tr> <td>802.11g: 6, 9, 12, 18, 24, 36, 48, 54Mbps</td> </tr> <tr> <td rowspan="3">Transmit Power(EIRP)</td> <td>11n HT40 MCS7 : +13 dBm</td> </tr> <tr> <td>11g OFDM: +15 dBm</td> </tr> <tr> <td>11b CCK: +18 dBm</td> </tr> <tr> <td>Security</td> <td>WEP 64/128, TKIP, WPA, WPA2 mixed, 802.1x and 802.11i</td> </tr> </table> <p>Sensitivity: 100 (The image is recognized as a black and white one)</p>	Standard	IEEE 802.11 b/g/n standards compliant	Wireless LAN	1T1R Mode	Frequency Range	2.400 ~ 2.4835GHz (subject to local regulations)	Number of Selectable Channels	802.11n: 20MHz/40MHz	USA, Canada (FCC): 11 channels (2.412GHz~2.462GHz)	802.11b/g: Europe (CE): 13 channels (2.412GHz~2.472GHz)	Japan (TELECOM): 14 channels (2.412GHz~2.4835GHz)	Data Rate	802.11n: up to 150Mbps	802.11b: 1, 2, 5.5, 11Mbps	802.11g: 6, 9, 12, 18, 24, 36, 48, 54Mbps	Transmit Power(EIRP)	11n HT40 MCS7 : +13 dBm	11g OFDM: +15 dBm	11b CCK: +18 dBm	Security	WEP 64/128, TKIP, WPA, WPA2 mixed, 802.1x and 802.11i
Standard	IEEE 802.11 b/g/n standards compliant																																										
Wireless LAN	1T1R Mode																																										
Frequency Range	2.400 ~ 2.4835GHz (subject to local regulations)																																										
Number of Selectable Channels	802.11n: 20MHz/40MHz																																										
	USA, Canada (FCC): 11 channels (2.412GHz~2.462GHz)																																										
	802.11b/g: Europe (CE): 13 channels (2.412GHz~2.472GHz)																																										
	Japan (TELECOM): 14 channels (2.412GHz~2.4835GHz)																																										
Data Rate	802.11n: up to 150Mbps																																										
	802.11b: 1, 2, 5.5, 11Mbps																																										
	802.11g: 6, 9, 12, 18, 24, 36, 48, 54Mbps																																										
Transmit Power(EIRP)	11n HT40 MCS7 : +13 dBm																																										
	11g OFDM: +15 dBm																																										
	11b CCK: +18 dBm																																										
Security	WEP 64/128, TKIP, WPA, WPA2 mixed, 802.1x and 802.11i																																										
Standard	IEEE 802.11 b/g/n standards compliant																																										
Wireless LAN	1T1R Mode																																										
Frequency Range	2.400 ~ 2.4835GHz (subject to local regulations)																																										
Number of Selectable Channels	802.11n: 20MHz/40MHz																																										
	USA, Canada (FCC): 11 channels (2.412GHz~2.462GHz)																																										
	802.11b/g: Europe (CE): 13 channels (2.412GHz~2.472GHz)																																										
	Japan (TELECOM): 14 channels (2.412GHz~2.4835GHz)																																										
Data Rate	802.11n: up to 150Mbps																																										
	802.11b: 1, 2, 5.5, 11Mbps																																										
	802.11g: 6, 9, 12, 18, 24, 36, 48, 54Mbps																																										
Transmit Power(EIRP)	11n HT40 MCS7 : +13 dBm																																										
	11g OFDM: +15 dBm																																										
	11b CCK: +18 dBm																																										
Security	WEP 64/128, TKIP, WPA, WPA2 mixed, 802.1x and 802.11i																																										

Same settings on both sides:

Click to apply same scan settings for both sides of your documents. After checking this option, any settings you have changed will automatically applied to both the front side and the rear side. For example, if you choose your ideal resolution to be 300 dpi, this will be applied both to the front side and rear side of your document.

Other Image Options

Binarization This is the process of converting a grayscale or color image to a bi-tonal image. There are several different methods of performing this conversion. **Options: Dynamic Threshold, Fixed Processing, Halftone 1~5, Error Diffusion.**

Dynamic Threshold: Selecting **Dynamic Threshold** allows the scanner to dynamically evaluate each document to determine the optimal threshold value to produce the highest quality image. This is used to scan mixed document containing faint text, shaded background, or color background with a single setting. If Dynamic Threshold is selected, Threshold, Brightness, and Contrast are not available.

Dynamic Threshold (AD): Selecting **Dynamic Threshold (AD)** to perform the enhanced mode of the Dynamic Threshold feature. However, using this mode may slow down your scanning speed.

Sensitivity of Dynamic Threshold

Occasionally your scanned image may contain small dots or speckles. To remove these spots, increase the sensitivity value by moving the bar to the right. The value ranges from 1 to 30. The default is 20.

Fixed Processing: Used for black-and-white and other high contrast documents. A single level is set to determine the black-and-white transition. The threshold is programmable over the entire density range. **Fixed Processing** sets Contrast to 0. If **Fixed Processing** is selected, Contrast is not available.

Halftone: In addition to the black and white display, Halftone can present a somehow gray shade of image by using different size of dots. Halftone image looks like the picture we have seen in the newspaper. **Options include Halftone 1, Halftone 2, Halftone 3, Halftone 4, Halftone 5.**

Error Diffusion: Error Diffusion is a type of Halftone. Error Diffusion gives good image texture and makes text in images more readable than Halftone.



Halftone Image



Error Diffusion Image

<p>Dynamic Threshold</p>	<p>Dynamic Threshold (AD)</p>

Threshold

Used to convert a grayscale image to a bi-tonal image. The value ranges from 0 to 255. A low threshold value produces a lighter image, and can be used to subdue backgrounds and subtle, unneeded information. A high threshold value produces a darker image, and can be used to help pick up faint images.

Adjust the threshold setting by dragging the Threshold sliding bar to the left or right to achieve the desired threshold setting.

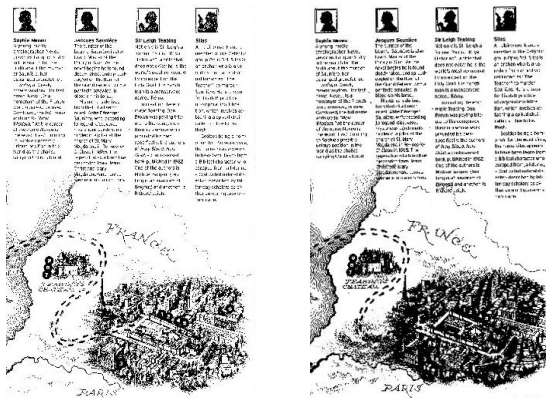

**200 dpi,
Threshold:50,
Brightness: 0**

**200 dpi,
Threshold:100,
Brightness: 0**

Gray

Document Type: Choice: Normal, Photo, Document

Three options of document type are provided when you choose Gray as the image type for your scanned document. Choice: Normal, Photo, Document.

- **Document:** Choose Document if your original contains pure text or a mixture of text and graphic since it is an optimal setting for regular business document. When using Document, only Threshold can be adjusted.
- **Photo:** Choose Photo if your original contains photo to reproduce your photo in vivid grayscale image. When using Photo, no Threshold and Contrast can be adjusted.
- **Normal:** When using **Normal**, Threshold, Brightness, and Contrast can be adjusted.

Threshold: The value ranges from 0 to 255. The default is 230. A low threshold value produces a lighter image, and can be used to subdue backgrounds and subtle, unneeded information. A high threshold value produces a darker image, and can be used to help pick up faint images. Adjust the threshold setting by dragging the **Threshold** sliding bar to the left or right to achieve the desired threshold setting.

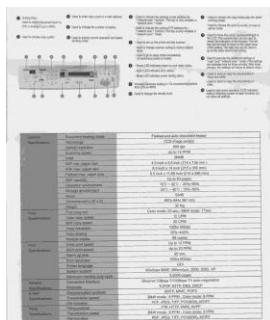

Normal

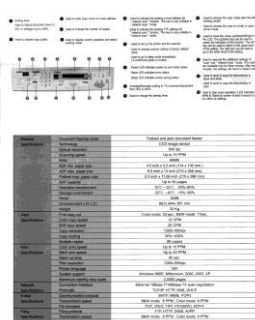

Photo

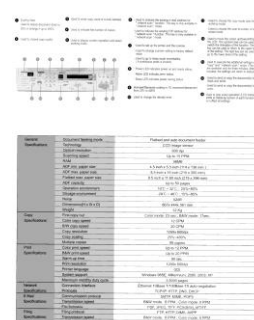

Document
(Threshold: 230)



Normal



Photo



Document
(Threshold: 230)

Brightness Adjusts the lightness or darkness of an image. The higher the value, the brighter the image. Drag the slider to the right or left to increase or decrease the brightness. The range is from -100 to +100.

Contrast Adjusts the range between the darkest and the lightest shades in the image. The higher the contrast, the bigger the different grayscale. Drag the slider to the right or left to increase or decrease the contrast. The range is from -100 to +100.

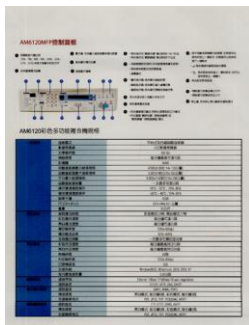

Brightness: -50

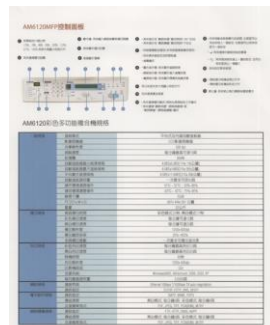

**Brightness: 0
(Normal)**

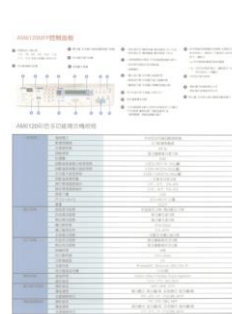

Brightness: +50

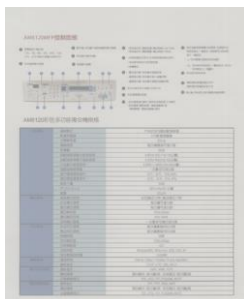

Contrast: -50

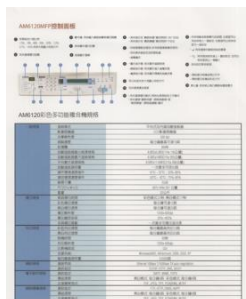

**Contrast: 0
(Normal)**

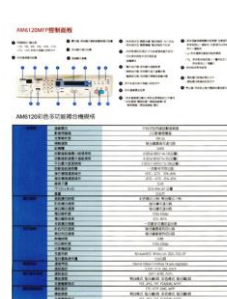

Contrast: +50

Resolution

A good control of the resolution results a good detail of an image that scans. The resolution is measured by dots per inch (dpi). Normally, the greater the dpi number, the higher the resolution and the image file size. Be aware that greater resolution takes more time to scan, and more disk space for the scanning image. For your information, an A4 size color image scanned at 300 dpi at True Color mode consumes approximately 25 MB of disk space. A higher resolution (usually means over 600 dpi) is only recommended when you need to scan a small area at True Color mode.

Choose a resolution value from the drop down list. The default value is 200 dpi. Available resolutions are 75, 100, 150, 200,300, 400 and 600. Or you may choose your desired value by clicking the box in the right side of the drop down list and press the arrow key to select your desired value and then click the Add button to include it in the drop down list.

Note: The resolution is up to 300 dpi if an imprinter or a MICR reader is installed or connected to the scanner.



Resolution: 75 dpi



Resolution: 150 dpi

Invert Reverses the brightness and the colors in the image. The default setting is Black on a White background. Reverse mode is White on a Black background. For color images, each pixel will be changed into its complementary color at the command of Invert.

"I am not worthy to have you enter my
 that is God, I beg all my brothers - those w
 e who work manually, clerics and lay brothers
 ards being humble in all things; not to glorify
 r to become interiorly proud because of good w
 sometimes says or does in them or through th
 ord: "Do not rejoice... in the fact that the de
 : 10:20) Let us be firmly convinced of the fact

Black on White

"I am not worthy to have you enter my
 that is God, I beg all my brothers - those w
 e who work manually, clerics and lay brother
 ards being humble in all things; not to glorify
 to become interiorly proud because of good w
 sometimes says or does in them or through t
 ord: "Do not rejoice... in the fact that the de
 10:20) Let us be firmly convinced of the fac

White on Black

Scan Choice:

- Source**
- **Auto Document Feeder:** Used to scan multiple pages.
 - **Flatbed:** Used to scan a single page. For example, pages from newspaper clipping, paper with wrinkles or curls.
 - **Flatbed (book):** Used to scan several inside pages from book.
 - **Automatic:** Allow the scanner automatically set its scan source. If **Automatic** is selected and there is document in both the auto document feeder (ADF) and the flatbed, then the scan source will be automatically set to ADF. If **Automatic** is selected and there is document only in flatbed, then the scan source will be set to flatbed.
 - **Merge Two Sides into One Image:**
 If you have a sheet-fed duplex scanner with front input tray, you can scan an A3 size document with an innovative method. Thus, fold your A3 size document into A4, and then load the paper in the front tray. Choose Merge Two Sides from the Scan Source option and then the scanner is able to scan both sides of your document and merge two A4 images into one A3 image.

When you select Merge Two Sides into One Image, the Cropping

or Multi-feed function will be disabled.

Note: This feature must be used with a carrier sheet. Regarding how to load a document with a Carrier Sheet, refer to Section 4.6.2, Other Paper Selection.

Note the options vary based on type of scanner.

If "Merge Two Sides into One Image" is selected, its choice will be available including "Merge Horizontally", "Merge Vertically", "Merge Vertically (Back Side Flip)". If the reverse side of your document is upside down, choose "Merge Vertically (Back Side Flip)" and the back side will be automatically rotated 180 degrees and merged.

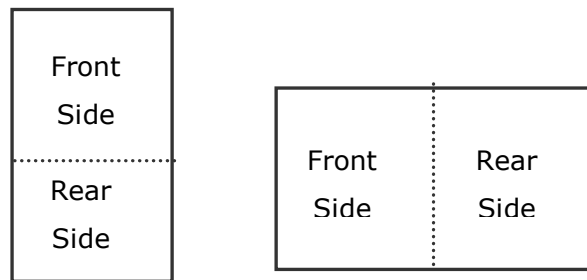

Merge Vertically

Merge Horizontally

Note the options vary based on type of scanner.

Color Matching

The purpose of Color Matching is getting the accurate color. This option uses the default parameters (ICC profile) to adjust the colors of the image.

Choice: None, Document, Photo

- **None:** Choose "None" to disable this option.
- **Document:** Choose "Document" if your original contains pure text or a mixture of text and graphic since it is an optimal setting for regular business document.
- **Photo:** Choose "Photo" if your original contains photo to reproduce your photo in vivid color image.



Normal



After Color Matching

Scanning Color Images

The following options are available for scanning color images.

- Brightness
- Contrast
- Resolution
- Invert

Scanning Grayscale Images

The following options are available for scanning gray images.

- Brightness
- Contrast
- Resolution
- Invert

Scanning B&W Images

The following options are available for scanning B&W images.

- Binarization (Dynamic Threshold)
- Resolution
- Invert

Or

- Binarization (Fix Processing)
- Threshold
- Brightness
- Resolution
- Invert

Editing Profiles

The Scanner Properties dialog box allows you to change and save your frequently used scan settings into a profile. You can edit these profiles by renaming or deleting them.

To add a new profile,

1. Customize your settings. (For example, change your resolution, image type, cropping method, scan size, or other scan settings.)
2. Click the Image tab and then choose "Profiles" to prompt the "Edit Your Profile" dialog box.

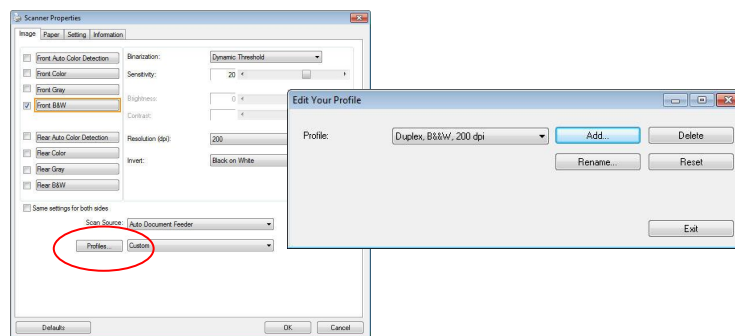

3. Click "Add" to enter the name of the profile and then choose "Save".



4. The new profile will be saved and shown in the "Profiles" dropdown list box.

To load a profile,

1. From the Image tab dialog box, choose your favorable profile from the "Profiles" dropdown list box.

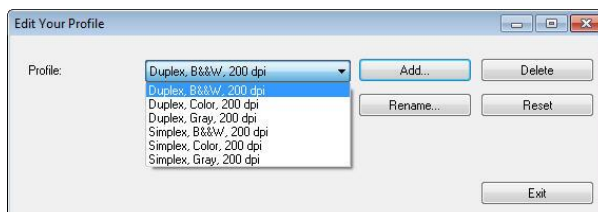

2. Your favorable profile will be immediately loaded and displayed on Scanner Properties dialog box.

To delete a profile,

1. From the Image tab dialog box, click "Profiles" to prompt the Edit Your Profile dialog box.

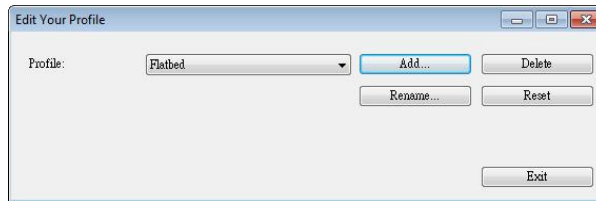

2. Choose the profile you want to delete from the dropdown list box.
3. Click "Delete". A Confirm message "Are you sure you want to delete this profile?" is prompted.
4. Choose "Yes" to delete or "Cancel" to quit.

To rename a profile,

1. From the Image tab dialog box, click "Profiles" to prompt the Edit Your Profile dialog box.

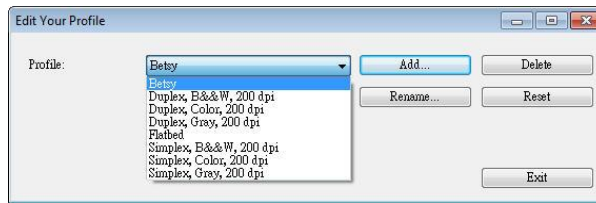

2. Choose the profile you want to rename from the dropdown list box and then click the Rename button.
3. Enter new name for the profile.



4. Choose "Save" to save the new profile or "Cancel" to quit.

Note:

The preset default profiles include Flatbed, Simplex-B&W, 200 dpi, Simplex-Gray, 200 dpi, Simplex-Color, 200 dpi, Duplex-B&W, 200 dpi, Duplex-Gray, 200 dpi, Duplex-Color, 200 dpi. If you have a simplex or a sheetfed scanner, the duplex or the flatbed option will not be available.

The Compression Tab

The Compression tab allows you to compress your scanned image and choose the level of compression. Bi-tonal images are normally compressed using CCITT standard called Group 4 (G4). Color and grayscale images are often compressed using JPEG technology. Move the **JPEG Quality** slider to the right or left to increase or decrease the level of compression. Note the greater the compression level, the lower image quality. Default is 50%.

Note that the compression depends on your image editing application. If your image editing application does not support the type of compression format, then either a warning message will appear or the image quality of the compressed file will not be acceptable.

JPEG (Joint Photographic Editor Group). This group developed and lent their name to a file compression standard for color and grayscale images that is widely used by scanners, and software applications. On Microsoft Windows-based systems, a file with the extension .jpg has normally been compressed using this standard.

For scanning color or gray images, the following compressions are available:

- None
- JPEG

For scanning B&W images, the following compressions are available:

- None
- G4

Compression:

To complete your scan at a rated speed, the scanned image is compressed by default during transmission. However, if you wish to obtain the highest image quality, you can choose to uncompress the image data before it is outputted.

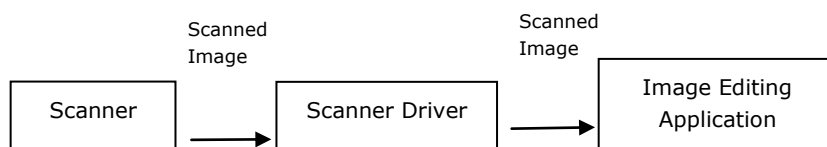

To Application:

Choose if you wish to compress the image data and transfer it from the TWAIN driver to the application. Note Bi-tonal images are normally compressed using CCITT standard called Group 4 (G4). Color and grayscale images are often compressed using JPEG technology. Move the [**Image Quality**] slider to the right or left to increase or decrease your image quality. Note the greater the image quality, the lower the compression level. Default is 50%.

Note that the compression depends on your image editing application. If your image editing application does not support the type of compression format, then the image of the compressed file will look abnormal.

From Scanner: (Note: The availability of this feature varies due to scanner model.)

Choose if you wish to compress the scanned image and transfer it from the scanner to the TWAIN driver.

Choice: Uncompressed, *Best Image Quality (Low Compression Level), Better Image Quality (Normal Compression Level), Normal Image Quality (High Compression Level). (*: Factory Default)

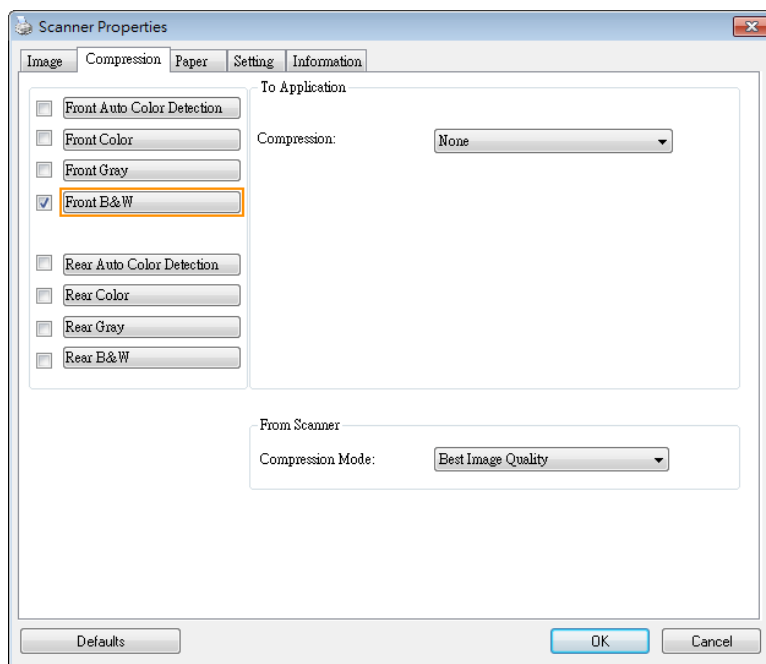

The Compression tab dialog box

The Color Dropout Tab

Color Dropout Selection

The [Color Dropout] tab allows you to select either green, red, blue, or a color of your choice to remove the details of the selected color from a scanned image. This feature is used to sharpen your text when using OCR (Optical Character Recognition) software. Note this feature applies only to the gray or black and white image.

Choice: None, Auto, Remove Red, Remove Green, Remove Blue, Custom

- **None:** Does not remove any color.
- **Auto:** Automatically outputs the image with the details of the primary color removed.
- **Remove Red/Remove Green/Remove Blue:** Outputs the image with the details of the specified color removed.
- **Custom:** Specify the color you wish to remove by entering its RGB (Red, Green, and Blue) value respectively.

Advanced Options:

- **Quality Mode:** Range: 0~20. Default: 10

When [Quality Mode] is selected, you can determine the color to be dropped out using the [Filter Threshold] slider. A lower value will drop more of the selected color out, while a higher value will leave more of the selected color in.

- **Normal Mode:** Use an optimized setting to determine the color.

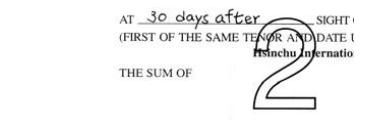
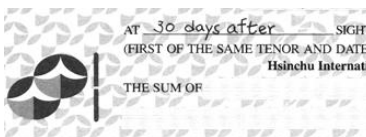
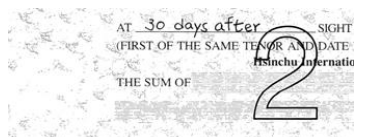
 <p>Original</p>	 <p>Auto/Remove Green (normal mode)</p>
 <p>Remove Red (normal mode)</p>	 <p>Remove Green (quality mode: Threshold: 18)</p>

Preview the color dropout result:

To preview the color dropout result, please follow these steps:

1. Click the [**Scanner Properties**] icon () on the upper left corner, and choose [**Tab**] to show available tab names.
2. Choose [**Preview**] to show the Preview tab.
3. Click the [**Preview**] tab to show the Preview page.
4. Load your document to the scanner and click the [**Preview**] button to get a preview image.
5. On the [Image] tab, click [Gray] or [Black and White] image mode and then choose [Custom] on the [Color Dropout] tab. A [Preview window] button will be displayed.
6. Click the [**Preview window**] button to prompt the [**Preview**] window with the previewed image.
7. Move your cursor over the preview image. Your mouse cursor now becomes an Eyedropper.
8. Click to select a color which you wish to remove.
9. Click and hold your mouse button to view the result after removing the specified color. If the result is satisfactory, click [**OK**] to close the Preview window.

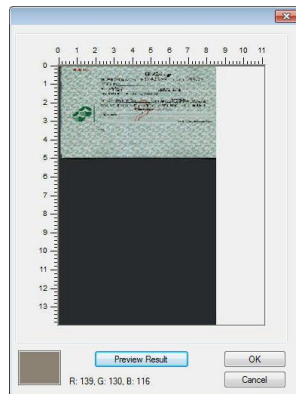

The Preview Window

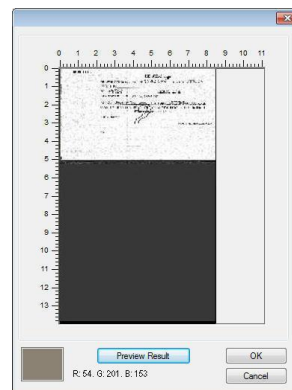

The Color dropout result

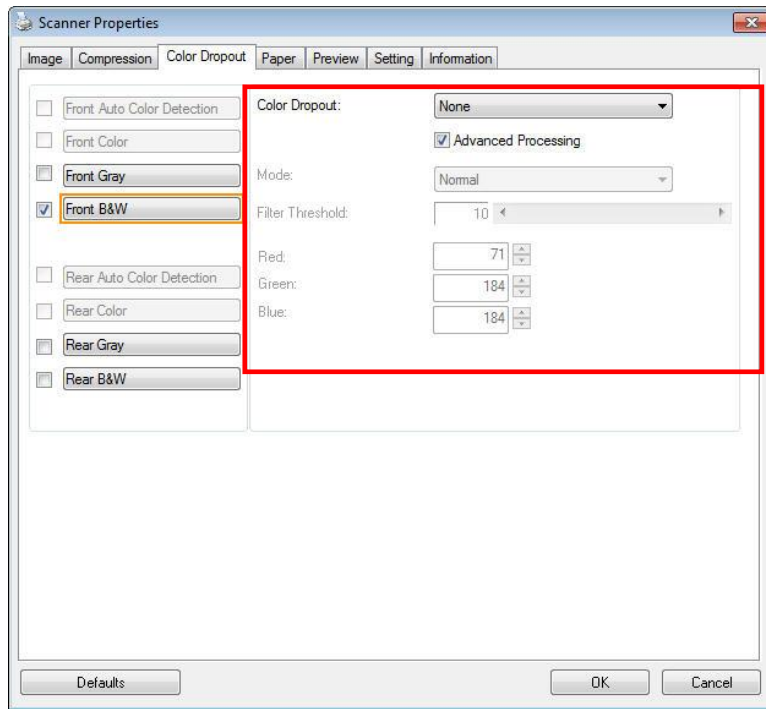

The Color Dropout dialog box

To select a color on the Color palette,

1. Click the Color Dropout tab from the Scanner Properties dialog box.

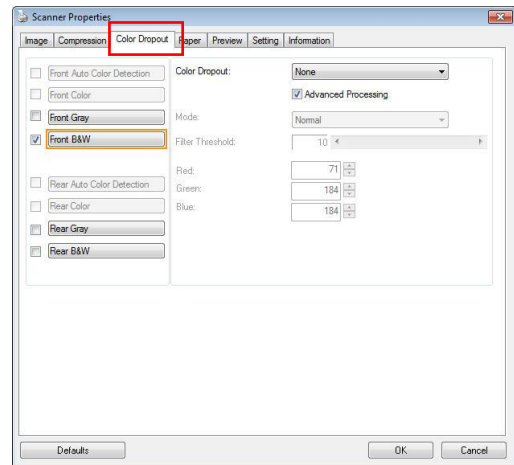

2. Choose Gray or B&W from the Image Selection box and click "Custom" from the Color Dropout drop-down menu. The Color palette appears.

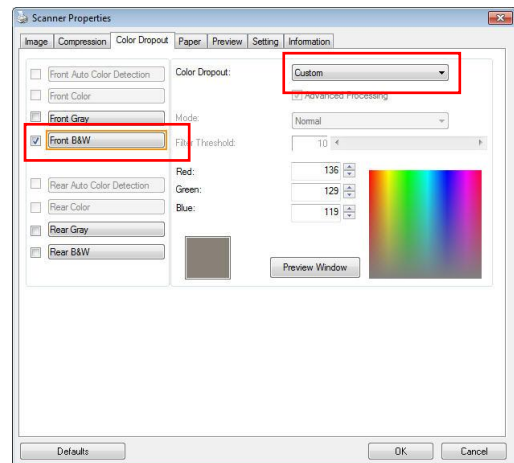

3. Move your cursor over the palette. The cursor becomes a cross sign.

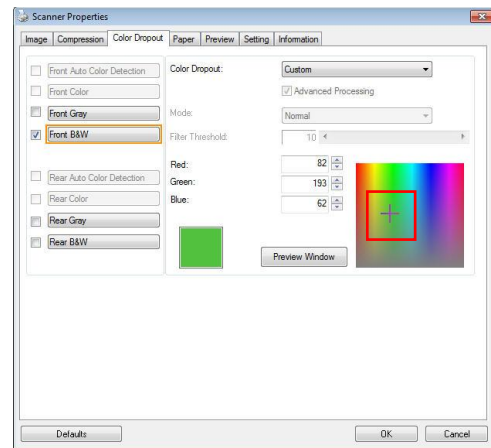

4. Click to choose a color. The RGB values are changed simultaneously.

The Paper Tab

The Paper tab allows you to define values relating to image output (i.e., Auto Crop or not, Scan Area, OverScan, Multi-Feed Detection).

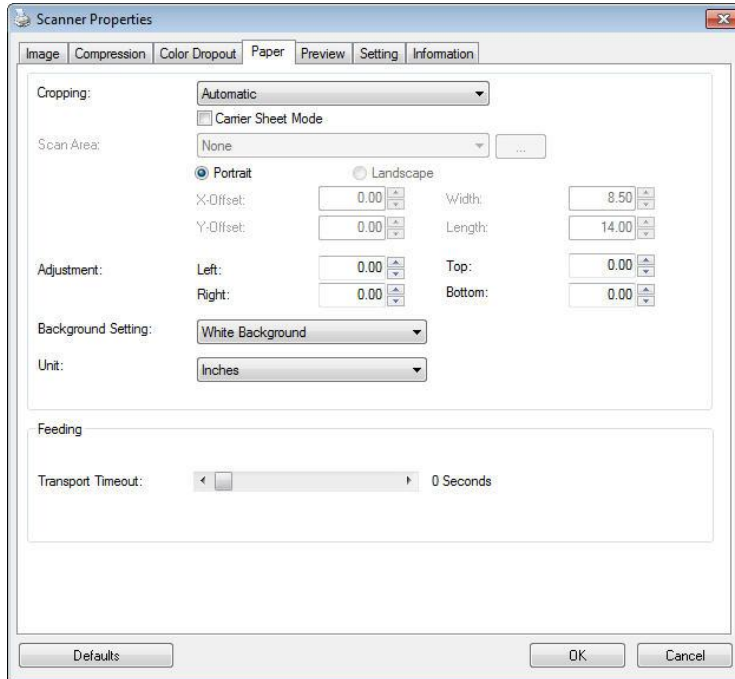

The Paper tab dialog box

Cropping

Cropping allows you to capture a portion of the document being scanned.
Choice: Automatic, Automatic (36"), Fixed to Transport, EOP (End of Page) Detection, Automatic Multiple, Relative to Documents.

Options	Description
Automatic	Automatic adjusts the cropping window according to different document sizes and automatically straighten a skewed document. Use this option for batches of mixed-sized documents.
Automatic (36")	Automatically adjusts the cropping window according to different document sizes smaller than 36" and automatically straighten a skewed image. Use this option for batches of mixed-sized document. Note: The availability of this feature varies due to the scanner model.

Fixed to Transport	This feature allows you to define the area or zone to be imaged. Use for batches of same-sized documents. If you select this option, you can use the arrow keys to define the x and y offset values, width and length to redefine your scanned area. The Display window will show image placement as you change the values.
EOP (End of Page) Detection	This feature allows you to define the area or zone to be imaged. Use for batches of same-width but different length documents. If you select this option, you can use the arrow keys to define the x and y offset values, width and length to redefine your scanned area. The Display window will show image placement as you change the values.
Automatic Multiple	This option allows you to place various sized documents such as photos, ID Cards, or business cards on the flatbed (if available) and lets you create multiple individually cropped images in one scan. Note: To correctly create multiple images, please make sure there is at least 12mm (0.5") of space between each document.
Relative to Document	This option allows you to crop different areas on your documents and deliver these images in B&W, Gray, or Color separately. For example, there are applications which require you to store the entire document in B&W and a part of the document in color to save storage space. This is useful for documents where a photograph or signature appears in a consistent area on the document such as resumes, and so on.

The following options are only available when **Fixed to Transport** is selected.

- **X-Offset** — the distance from the left end of the scanner to the left edge of the scanning area.
- **Y-Offset** — the position from the top end of the document to the top end of the scanning area.
- **Width** — the width of the scanning area.
- **Length** — the length of the scanning area.
- **Center:** automatically calculates the x-offset for center-fed feeding based upon document size selected.



-  — relocate the scan area by click the arrow key on the cross sign while retain the scan size. View the result from the Display window.

The Adjustment option is available when **Automatic** is selected.

- **Adjustment** —adds a positive/negative margin value Top/Bottom or toward left/right of the image. Adjustment is used when the automatic document feeder is used. Adjustment reduces the possibility of corner clipping on skewed images. To set Adjustment values, use the UP/Down buttons to select where you want to apply Adjustment values: Top/Bottom or Left/Right, and then select the amount of inches/mm/pixels applied. Select a value within the range of 0.00 to 1.00 / -1.00.

Relative to Document: (used for batches of same-sized documents)

This option allows you to crop different areas on your documents and deliver these images in B&W, Gray, or Color separately. For example, there are applications which require you to store the entire document in B&W and a part of the document in color to save storage space. This is useful for documents where a photograph or signature appears in a consistent area on the document such as resumes, and so on.

The following procedure describes how to reproduce the entire document in B&W and a portion of document (picture) in color.

1. On the Paper tab, choose "Relative to Document" or "Fixed to Transport" from the Cropping option.
2. Choose your scan size from the Scan Area option. The selected scan size will be displayed in a red rectangular box. This is also the scan size of your entire document. (For example, ISO B5. If you have not chosen a scan area and leave the selection as None, then the default area will be the scanner's maximum.)

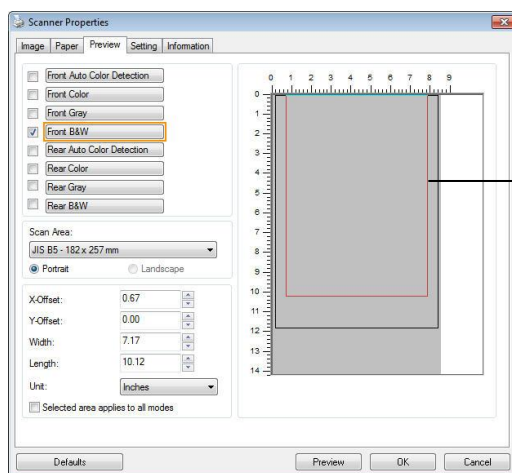

A red rectangular box

- Click the Preview tab to display the Preview window. A black rectangular box appears to indicate the max. scan size you have just selected.

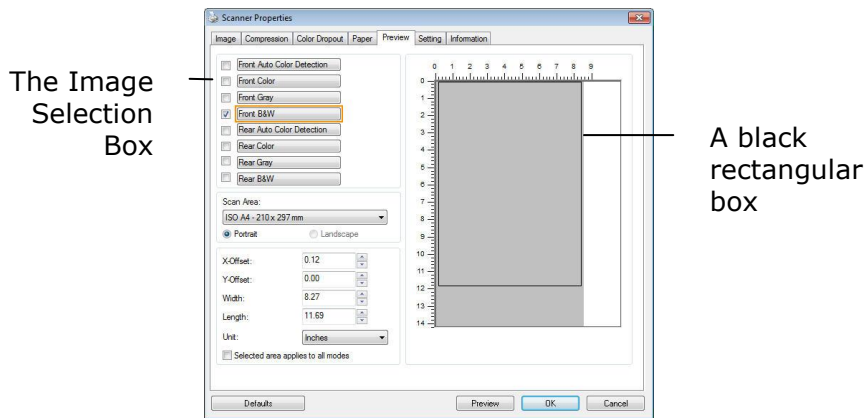

- Click the Preview button to view the entire image in low resolution to correctly crop your relative scan area.

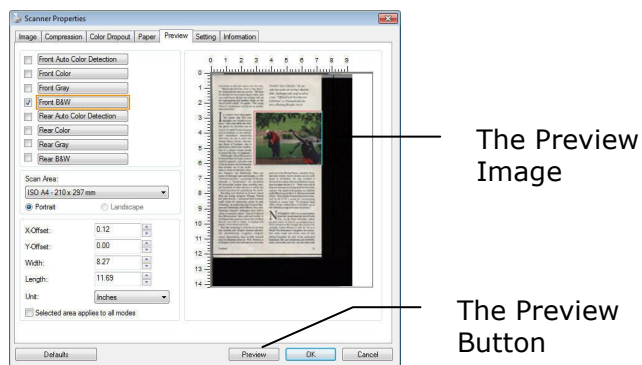

- Select image type from the Image Selection box. The selected image will appear in highlighted color. (For example, Front Color)
- Place your cursor on the Preview window and click your left mouse button. A cross sign will appear as illustrated. Create your relative scan size diagonally by dragging the left mouse button to your preferable size. The selected area will appear in a red box as illustrated.

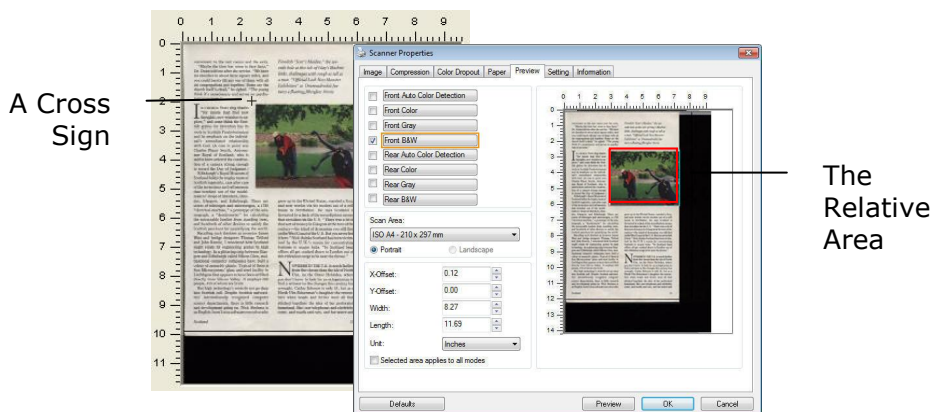

7. Check the B&W image from the Image Selection box to scan the entire document.
8. Click the Scan button to start scanning the document in two image types and sizes. (See the result in below.)



The entire document in B&W



The relative area in color

Other Paper Selection

Carrier Sheet Mode:

Check this option to automatically crop the scan window according to your document size when scanning non-standard document (fragile, irregular-size document) with a carrier sheet (optional). Note: The availability of this option varies due to scanner model.

Loading Documents Using a Carrier Sheet

A Carrier Sheet is a plastic sheet specifically used for loading non-standard document onto the scanner. It allows you to scan document that can not be scanned in the regular way. Also, documents larger than A4 size, such as A3 and B4, can be scanned by folding in half, inserting into the Carrier Sheet, and scanning in duplex mode. You can also scan documents that can be damaged quite easily such as photographs, or irregular size documents that are difficult to load directly such as clippings.

To scan document using a Carrier Sheet,

For documents larger than A4/Letter size, such as A3

- a. Fold the sheet to be scanned in half.
- b. Fold the sheet tightly and smooth out crease. Otherwise, the sheet may be skewed during scanning.

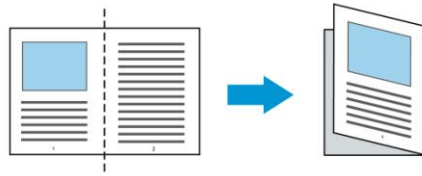

1. Open the Carrier Sheet and place the document inside.

Align the top of the document to the top of the Carrier Sheet (the printed area).

For documents larger than A4/letter size, such as A3

Align the top of the document to the top of the Carrier Sheet (the printed section) and the folded portion to the right edge of the Carrier Sheet so that the document fits into the Carrier Sheet at the upper corner.

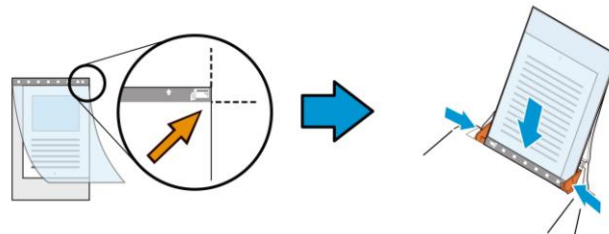

For non-standard document

Center your document in the Carrier Sheet.

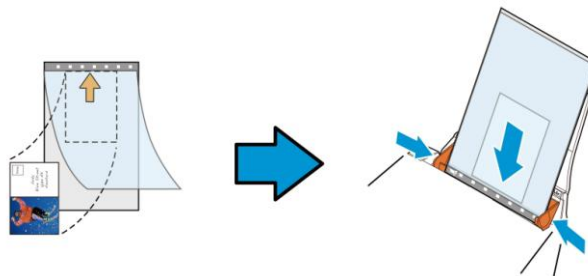

2. Load the Carrier Sheet with the gray section (printed section) facing downwards.
3. Adjust the paper guides to the width of the Carrier Sheet.
Adjust the paper guides so that there is no space between the guides and the Carrier sheet. Space between the guides and Carrier Sheet may cause the Carrier Sheet to become unaligned during scanning, and skew the scanned image.
4. Start the scan.

Notice:

- [Carrier Sheet] is available for the models that support the Carrier Sheet.
 - Some functions are disabled when [Carrier Sheet] is checked.
 - This option may not work properly on some applications.
-

Scan Area

Choose your desired paper size with the drop-down list box. Or you may select a custom paper size by clicking the **Scan Area** box and then click **Add** to include in the choice.

Choices are listed below:

None
US Letter- 8.5"x 11"
US Legal – 8.5" x 14"
ISO A4 – 21 x 29.7 cm
ISO A5 – 14.8 x 21 cm
ISO A6 – 10.5 x 14.8cm
ISO A7 – 7.4 x 10/5 cm
ISO B5 – 17.6 x 25 cm
ISO B6 – 12.5 x 17.6 cm
ISO B7 – 8.8 x 12.5 cm
JIS B5 – 18.2 x 25.7 cm
JIS B6 – 12.8 x 18.2 cm
JIS B7 – 9.1 x 12.8 cm
Scanner Maximum
Long Page (<118")

Long Page (<118"):

When you need to scan documents whose length exceeds scanner maximum, please choose **Long Page**. Note if **Long Page** is selected, the **Multi-Feed Detection** will not be available. (Note: This option and the maximum allowable document length vary due to type of scanner.)

When **Long Page (<118")** is selected, be sure to specify your document size in the **Length** and **Width** field.

Notice when scanning long page document:

1. Pull out the extension in the ADF Paper Tray.
 2. Secure enough space around the Output Tray to prevent the ejected paper from falling off the Output Tray.
 3. To ensure the performance, in color mode, set the resolution to be 300 dpi or lower; in Black and White mode, set the resolution to be 600 dpi or lower.
 4. Depending on your system environments, application, or your specified paper size, there may be insufficient memory to perform scanning.
-

OverScan

OverScan allows you to add a specific margin at top and bottom or right and left (Options vary based on the type of scanner) of the edge of the image. This is used to reduce possible corner clipping on the skewed images and often applied to a batch of skewed document to be scanned in the auto document feeder. Select a value between 0 and +5 mm. Note the overscan result will not be shown in the Display window and that the availability of the function varies based on type of scanner.

Pre-Feed

Choice: Enable, Disable. If enable is selected, you can set the amount of time the scanner starts pre-feeding your paper after your documents has been loaded into the feeder. The default is disable. Note: The availability of this option varies due to scanner model.

Transport Timeout

Set the amount of time the scanner will wait and then start auto scan after the first scan job is completed. If you have many separate documents need to be scanned at the same scan settings, this feature is especially useful. The default is 0. The value ranges from 0 to 30 seconds.

Note:

1. Within the specified timeout period, if you load your document to the feeder, the scanner starts scanning automatically.
 2. If your scanner has a flatbed option and you place your paper on the flatbed, after the timeout period, you need to click the Scan button on the TWAIN user interface to start scanning.
-

Background Setting

This option allows you to set your scan background. **Choice: White Background, Black Background.**

Note: For a sheet-fed scanner with an auto document feeder, this option is currently available only in the "Auto crop" mode. For a scanner with a flatbed platen, this option is available either in the "Auto crop" or the "Fixed to Transport" mode.

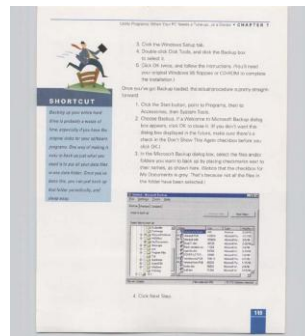

White Background

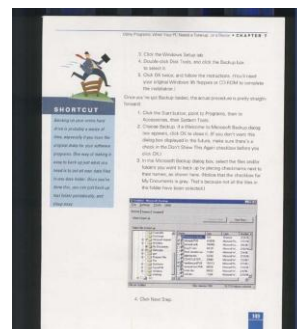

Black Background

The Multi-Feed Detection Tab

Multi-Feed Detection

Multi-Feed Detection allows you to detect overlapped document that go through the auto document feeder. Multi-Feed usually occurs due to stapled documents, adhesives on documents, or electro-statically charged document. Note : The availability of the function varies based on type of scanner.

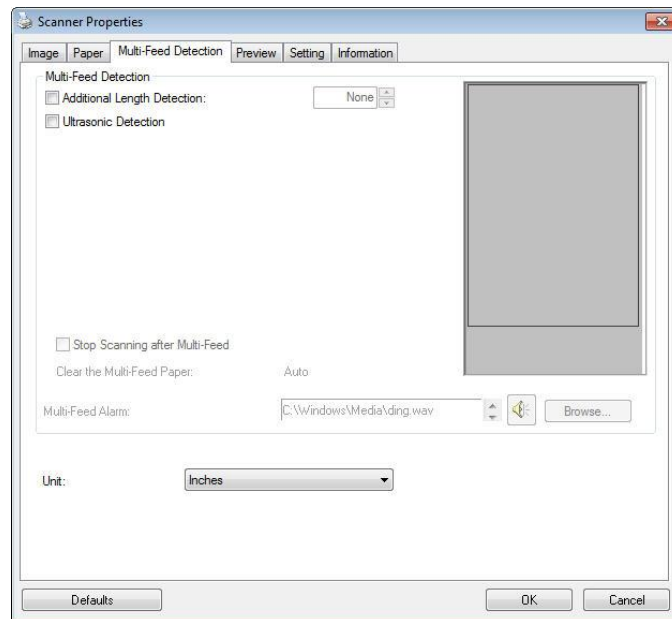

Additional Length Detection

Additional Length Detection allows you to define the length of document being multi-fed. This value indicates the additional length exceeding your scan area. The Display window will show the size of the document as you change the value. A value of 0 indicates no additional length detection. The Additional Length Detection is best used when scanning same-size documents in the auto document feeder.

Ultrasonic Detection

Ultrasonic Detection allows you to set overlapped document by detecting paper thickness between documents. Note : The availability of the function varies based on type of scanner.

There are two options available if Multi-Feed is detected.

- **Stop Scanning after Multi-Feed**

If this is selected, the scanner will stop the feeder and display the following Warning dialog box if multi-feed is detected.

Action:

1. Follow the instruction on the Warning dialog box to remove the rest pages on the feeder.
2. Click OK to close the Warning dialog box.
3. Scan the rest pages.

Clear the Multi-Fed Paper: Auto

If this is checked, once multi-feed is detected and scanning operation is stopped, the scanner will automatically clear the transport of the multi-fed paper. If this is not checked, once multi-feed is detected and scanning operation is stopped, you need to manually clear the transport of the multi-fed paper. Note: The availability of this option varies based on type of scanner.

● **Multi-Feed Alarm**

If a wave file is added, the scanner will make a sound alarm if multi-feed is detected yet no Warning dialog box will be displayed.

If "Stop Scanning after Multi-Feed" is selected, the scanner will stop the feeder.

If "Stop Scanning after Multi-Feed" has not been selected, the scanner will continue to scan till the end of your document.

Action:

1. If "Stop Scanning after Multi-Feed" is selected, follow the action described in the preceding section "Stop Scanning after Multi-Feed" on the previous page to complete your job.
2. If "Stop Scanning after Multi-Feed" has not been selected, rescan the pages where multi-feed is detected.

How to add the sound alarm :

1. Click the Browse button on the right side of the speaker icon. The Open dialog box appears.
2. Choose your wave file.
3. Click the Open button. The wave file is added.

Units

Defines the primary measurement system. **Inches, Millimeters, and Pixels** are available.

The Preview Tab

The Preview tab allows you to preview (a low-resolution scan) your image before final scan. This preview image lets you allocate your scan area. You can choose your scan area by the "Scan Area" drop down list box or placing your cursor on the Display window and dragging it diagonally on the Display window. Then, a red rectangle box will appear to indicate the selected area.

Note: If you choose "Automatic Cropping" on the "Paper Tab", then to select a scan area on the Preview tab is not allowed.

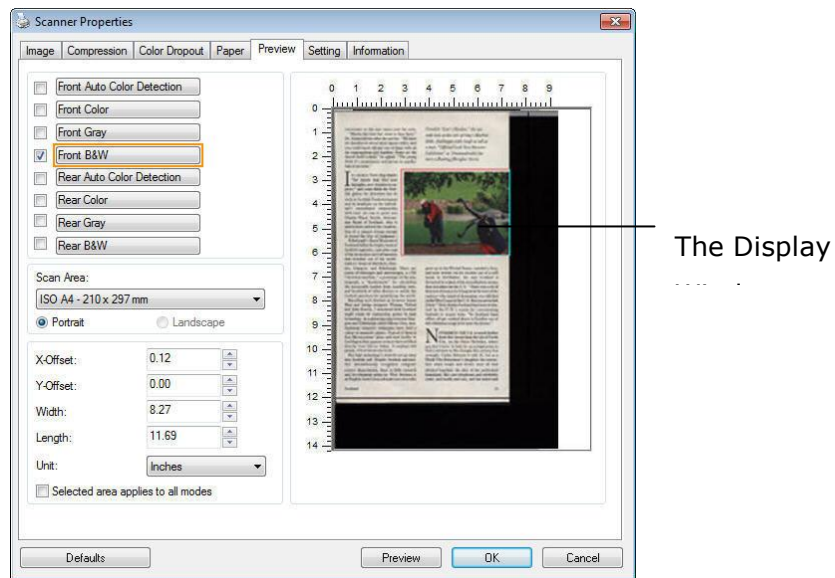

The Preview Tab

The Enhancement Tab

The Enhancement tab allows you to set following additional image processing settings.

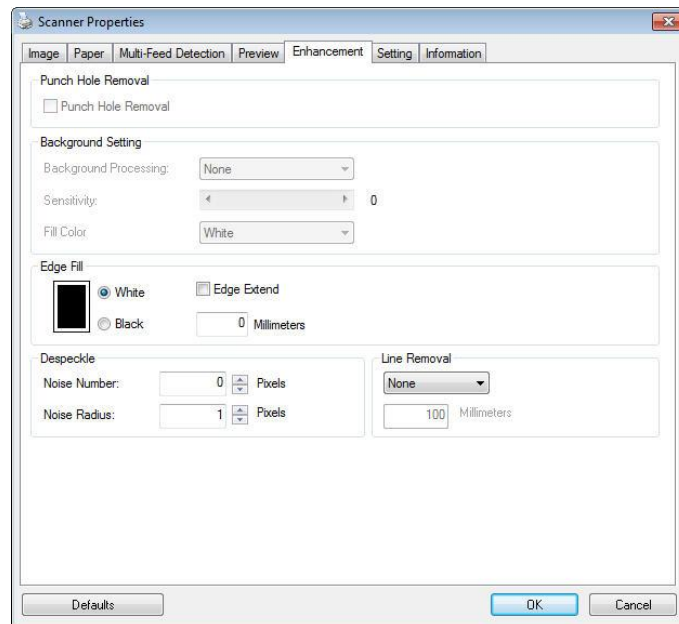

The Option tab dialog box

Punch Hole Removal You can remove punch holes from the output scanned image when scanning punched document. Note the availability of this feature varies depending on your scanner model.

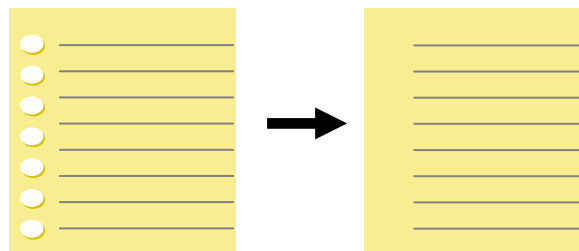

Original

Output image

Punch holes can not be removed when:

- Resolution is set lower than 150dpi
- The hole is near the edge of the document
- The holes are not aligned along the edge of the document
- Punch Hole Removal is available only when "Auto Crop" is enabled. If either "Fixed to Transport", "EOP (End of Page) Detection", "Automatic Multiple", "Relative to Documents" is selected from the Cropping option on the Paper tab, the Punch Hole Removal option will be disabled.

Shadow Removal

When 「Flatbed」 on the 「Scan Source」 option is selected on the 「Image」 tab, the 「Shadow Removal」 option will be enabled. Click to remove the shadow on the book spine when scanning a book.

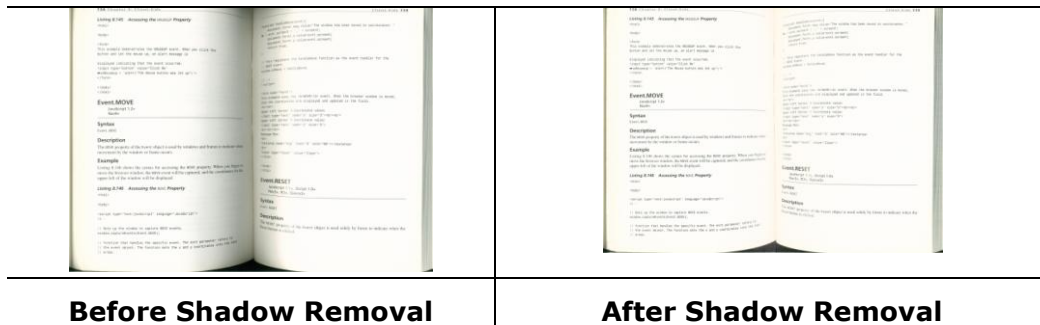

Background Processing: The [**Background Processing**] option allows you to smooth background color or remove it to make image clearer. The option is especially useful for documents with color forms such as invoices.

Choices: None (default), Smooth, Removal

- **None** - no background processing will be performed (default)
- **Smooth** - produces images with a more uniform background color. This option improves image quality.
- **Removal** - identifies the background color and then removes it.

Sensitivity: Choice: 0, 1, 2, 3, 4. Default: 0

- The higher the value, the more background color will be kept.

Mode: Auto, Moiré

If [**Smooth**] is selected in the [**Background Processing**] option, then the choices for the [**Mode**] option includes Auto, and Moiré.

- **Auto** - uses the factory preprogrammed mode to proceed background smoothing.
- **Moiré** - Remove the moiré patterns that appear on the background of the image when scanning printed material.

If [**Removal**] is selected in the [**Background Processing**] option, then the [**Mode**] option will be replaced with [**Fill Color**]. Choices: White, Auto.

- **White** - identifies the background color and substitutes it with white.
- **Auto** - identifies the background color and substitutes it with the color of the largest background zone.



Background Processing: None



Background Processing:

Smooth

Background Processing:

Removal

Fill Color: White

Note: Background color in small zone will not be processed or removed.

Edge Fill

Check White or Black if you wish to add white or black edge on the border of your scanned image. Enter the value from 0 to 5 mm. Default value is 0.

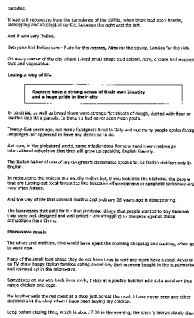

Original

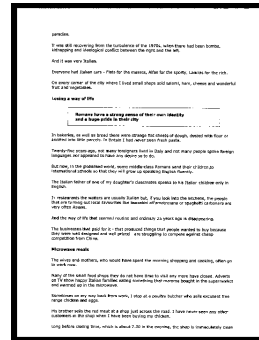

Edge Fill: 5mm (Black)

Despeckle

Occasionally small dots or specks appear in the background of a scanned image. Remove unwanted speckles provides a cleaner image for OCR (Optical Character Recognition) processing, and also helps to reduce compressed file size.

Define the speckles (also known as image noise) you wish to remove by specifying its number (size) and radius (range). The measuring unit is pixel. The higher the number, the more speckles will be removed.

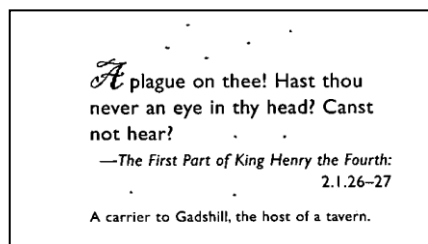

Before Despeckle

(noise number:0, noise radius:1)

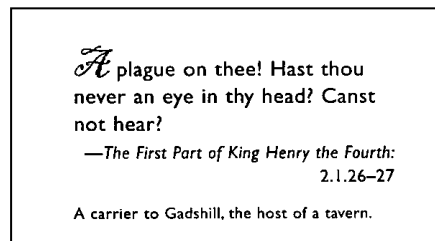

After Despeckle

(noise number:22, noise radius:10)

Note:

- The function is currently available for Black and White image only.
 - To scan at rated speed, it is recommended to set the noise radius up to 10 pixels.
-

Line Removal: When **Black and White** image mode is selected on the [Image] tab, the [Line Removal] option will be enabled. Line Removal erases lines on the image and then reconstructs characters so the OCR (Optical Character Recognition) accuracy can be improved.

Choices: None, Form, Horizontal, Vertical

None – the default mode which does not remove any line.

Form – remove any form in the document.

Horizontal – select [Horizontal] and then enter the length of horizontal line to remove only the horizontal line exceeding your specified length.

Vertical – select [Vertical] and then enter the length of vertical line to remove only the vertical line exceeding your specified length.

<p>Attn: Mr. David Wang Shipped by SST Technologies Inc. For U-Line Express Sailing on or about July 30, 2002 From Taiwan, R.O.C. to U.S.A. L/C No. Contract No. A1233</p> <table border="1"> <thead> <tr> <th>Marks & Nos.</th> <th>Description of Goods</th> <th>Quantity</th> <th>Unit Price</th> <th>Amount</th> </tr> </thead> <tbody> <tr> <td rowspan="3">ABC</td> <td>Amaret (Item No. 100)</td> <td>3 sets</td> <td>USD20.00</td> <td>USD60.00</td> </tr> <tr> <td>Amaret (Item No. 101)</td> <td>3 sets</td> <td>USD20.00</td> <td>USD60.00</td> </tr> <tr> <td>Amaret (Item No. 102)</td> <td>3 sets</td> <td>USD20.00</td> <td>USD60.00</td> </tr> <tr> <td colspan="2">Seattle P/O No. A1233 C/Ns: 1 Made in Taiwan R.O.C.</td> <td></td> <td></td> <td></td> </tr> <tr> <td>Total</td> <td></td> <td>5 sets</td> <td></td> <td>USD120.00</td> </tr> </tbody> </table>	Marks & Nos.	Description of Goods	Quantity	Unit Price	Amount	ABC	Amaret (Item No. 100)	3 sets	USD20.00	USD60.00	Amaret (Item No. 101)	3 sets	USD20.00	USD60.00	Amaret (Item No. 102)	3 sets	USD20.00	USD60.00	Seattle P/O No. A1233 C/Ns: 1 Made in Taiwan R.O.C.					Total		5 sets		USD120.00	<p>Attn: Mr. David Wang Shipped by SST Technologies Inc. For U-Line Express Sailing on or about July 30, 2002 From Taiwan, R.O.C. to U.S.A. L/C No. Contract No. A1233</p> <table border="1"> <thead> <tr> <th>Marks & Nos.</th> <th>Description of Goods</th> <th>Quantity</th> <th>Unit Price</th> <th>Amount</th> </tr> </thead> <tbody> <tr> <td rowspan="3">ABC</td> <td>Amaret (Item No. 100)</td> <td>3 sets</td> <td>USD20.00</td> <td>USD60.00</td> </tr> <tr> <td>Amaret (Item No. 101)</td> <td>3 sets</td> <td>USD20.00</td> <td>USD60.00</td> </tr> <tr> <td>Amaret (Item No. 102)</td> <td>3 sets</td> <td>USD20.00</td> <td>USD60.00</td> </tr> <tr> <td colspan="2">Seattle P/O No. A1233 C/Ns: 1 Made in Taiwan R.O.C.</td> <td></td> <td></td> <td></td> </tr> <tr> <td>Total</td> <td></td> <td>5 sets</td> <td></td> <td>USD120.00</td> </tr> </tbody> </table>	Marks & Nos.	Description of Goods	Quantity	Unit Price	Amount	ABC	Amaret (Item No. 100)	3 sets	USD20.00	USD60.00	Amaret (Item No. 101)	3 sets	USD20.00	USD60.00	Amaret (Item No. 102)	3 sets	USD20.00	USD60.00	Seattle P/O No. A1233 C/Ns: 1 Made in Taiwan R.O.C.					Total		5 sets		USD120.00
Marks & Nos.	Description of Goods	Quantity	Unit Price	Amount																																																					
ABC	Amaret (Item No. 100)	3 sets	USD20.00	USD60.00																																																					
	Amaret (Item No. 101)	3 sets	USD20.00	USD60.00																																																					
	Amaret (Item No. 102)	3 sets	USD20.00	USD60.00																																																					
Seattle P/O No. A1233 C/Ns: 1 Made in Taiwan R.O.C.																																																									
Total		5 sets		USD120.00																																																					
Marks & Nos.	Description of Goods	Quantity	Unit Price	Amount																																																					
ABC	Amaret (Item No. 100)	3 sets	USD20.00	USD60.00																																																					
	Amaret (Item No. 101)	3 sets	USD20.00	USD60.00																																																					
	Amaret (Item No. 102)	3 sets	USD20.00	USD60.00																																																					
Seattle P/O No. A1233 C/Ns: 1 Made in Taiwan R.O.C.																																																									
Total		5 sets		USD120.00																																																					
None	Remove Form																																																								
<p>Attn: Mr. David Wang Shipped by SST Technologies Inc. For U-Line Express Sailing on or about July 30, 2002 From Taiwan, R.O.C. to U.S.A. L/C No. Contract No. A1233</p> <table border="1"> <thead> <tr> <th>Marks & Nos.</th> <th>Description of Goods</th> <th>Quantity</th> <th>Unit Price</th> <th>Amount</th> </tr> </thead> <tbody> <tr> <td rowspan="3">ABC</td> <td>Amaret (Item No. 100)</td> <td>3 sets</td> <td>USD20.00</td> <td>USD60.00</td> </tr> <tr> <td>Amaret (Item No. 101)</td> <td>3 sets</td> <td>USD20.00</td> <td>USD60.00</td> </tr> <tr> <td>Amaret (Item No. 102)</td> <td>3 sets</td> <td>USD20.00</td> <td>USD60.00</td> </tr> <tr> <td colspan="2">Seattle P/O No. A1233 C/Ns: 1 Made in Taiwan R.O.C.</td> <td></td> <td></td> <td></td> </tr> <tr> <td>Total</td> <td></td> <td>5 sets</td> <td></td> <td>USD120.00</td> </tr> </tbody> </table>	Marks & Nos.	Description of Goods	Quantity	Unit Price	Amount	ABC	Amaret (Item No. 100)	3 sets	USD20.00	USD60.00	Amaret (Item No. 101)	3 sets	USD20.00	USD60.00	Amaret (Item No. 102)	3 sets	USD20.00	USD60.00	Seattle P/O No. A1233 C/Ns: 1 Made in Taiwan R.O.C.					Total		5 sets		USD120.00	<p>Attn: Mr. David Wang Shipped by SST Technologies Inc. For U-Line Express Sailing on or about July 30, 2002 From Taiwan, R.O.C. to U.S.A. L/C No. Contract No. A1233</p> <table border="1"> <thead> <tr> <th>Marks & Nos.</th> <th>Description of Goods</th> <th>Quantity</th> <th>Unit Price</th> <th>Amount</th> </tr> </thead> <tbody> <tr> <td rowspan="3">ABC</td> <td>Amaret (Item No. 100)</td> <td>3 sets</td> <td>USD20.00</td> <td>USD60.00</td> </tr> <tr> <td>Amaret (Item No. 101)</td> <td>3 sets</td> <td>USD20.00</td> <td>USD60.00</td> </tr> <tr> <td>Amaret (Item No. 102)</td> <td>3 sets</td> <td>USD20.00</td> <td>USD60.00</td> </tr> <tr> <td colspan="2">Seattle P/O No. A1233 C/Ns: 1 Made in Taiwan R.O.C.</td> <td></td> <td></td> <td></td> </tr> <tr> <td>Total</td> <td></td> <td>5 sets</td> <td></td> <td>USD120.00</td> </tr> </tbody> </table>	Marks & Nos.	Description of Goods	Quantity	Unit Price	Amount	ABC	Amaret (Item No. 100)	3 sets	USD20.00	USD60.00	Amaret (Item No. 101)	3 sets	USD20.00	USD60.00	Amaret (Item No. 102)	3 sets	USD20.00	USD60.00	Seattle P/O No. A1233 C/Ns: 1 Made in Taiwan R.O.C.					Total		5 sets		USD120.00
Marks & Nos.	Description of Goods	Quantity	Unit Price	Amount																																																					
ABC	Amaret (Item No. 100)	3 sets	USD20.00	USD60.00																																																					
	Amaret (Item No. 101)	3 sets	USD20.00	USD60.00																																																					
	Amaret (Item No. 102)	3 sets	USD20.00	USD60.00																																																					
Seattle P/O No. A1233 C/Ns: 1 Made in Taiwan R.O.C.																																																									
Total		5 sets		USD120.00																																																					
Marks & Nos.	Description of Goods	Quantity	Unit Price	Amount																																																					
ABC	Amaret (Item No. 100)	3 sets	USD20.00	USD60.00																																																					
	Amaret (Item No. 101)	3 sets	USD20.00	USD60.00																																																					
	Amaret (Item No. 102)	3 sets	USD20.00	USD60.00																																																					
Seattle P/O No. A1233 C/Ns: 1 Made in Taiwan R.O.C.																																																									
Total		5 sets		USD120.00																																																					
Remove Horizontal Line (over 30 mm)	Remove Vertical Line (over 70 mm)																																																								

The Rotation Tab

The Rotation tab allows you to set the following image rotating options:

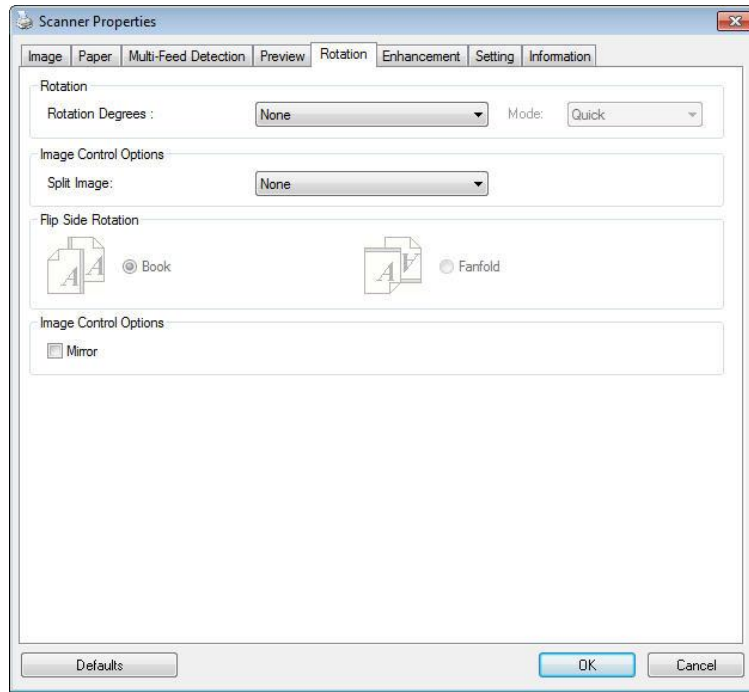

Rotate Image Choose the rotation angle from the drop down list if you wish to rotate your scanned image.

Choice: None, 90°CW(clockwise), 90°CCW(counter clockwise), 180°, Auto based on contents. Auto rotate every even page.

1 2 3

Original

3 2 1

Rotate 90°CCW

1
2
3

Rotate 90°CW

1 2 3

Rotate 180°

Auto based on contents: Automatically rotate images based on the contents of document. When 「**Auto based on contents**」 is selected, its modes will be enabled to let you select more options.

Mode: Quick, Full Text, Complexity

Quick – the default mode to let you rotate images at the fastest speed.

Full Text – the enhanced mode for documents with mixed text orientation.

Complexity – the enhanced mode yet at the slowest speed for document with complex image or text orientation.

Auto rotate every even page:

Automatically rotate 180° on every even page. This is especially useful when you scan the inside pages from a book. As a result, if you choose “Flatbed (book)” from the “Scan Source” option, “auto rotate every even page” will be selected as default.

Note: This option varies based on type of scanner.

<p>Document with various text orientations</p>	<p>Document with dark or complex background</p>

Split Image By splitting an image, two separate images are created horizontally or vertically. This is useful for documents containing two pages per image when you want to save them as two images (one page for one image). **Choice: None, Horizontal, Vertical.** Default is None.

Horizontal: Divide one image into the upper half and the lower half.

Vertical: Divide one image into the left half and the right half.



Split Horizontally



Split Vertical

**Flip Side
Rotation**

Select "fanfold" to rotate the image of the reverse side to 180 degrees.

This is applied to double-sided document which are viewed in portrait are sometime fed into the scanner in landscape or vice versa.

Choice: Book, Fanfold.

If "Book" is selected, the image of the reverse side will not be rotated.

The following illustration shows the documents which should be viewed in portrait are fed into the scanner in landscape



Image Control Option Check the Mirror box if you wish to reverse the right and left side of your image.



Original



The Mirror Effect

The Separation Tab

The Separation tab allows you to enable the detection engine to detect the blank page, barcode, and patch code and then notify the software application which supports document separation to separate your multi-page documents. Choices: Blank Page Removal, Barcode Detection, Patch Code Detection.

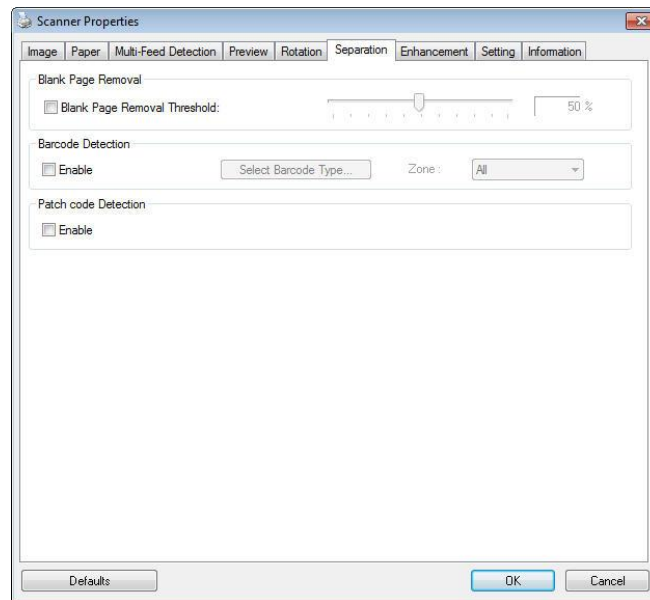

Blank Page Removal

Choices: None, Blank Page Removal Threshold, Image Size.

None – Do not remove the blank pages.

Threshold - Move the slider to the left or right to define your threshold for the blank page.

Image Size – Range: 1~ 10000 KB. Specify your desired image size to detect the page as a blank page. For example, if 3 KB is selected, any page less than 3 KB will be recognized as blank page.

Barcode Detection

Check [**Enable**] to detect barcode and notify the software application for advanced processing. Please note the whole document will be checked and no specific detection area needs to be designated.

When the bar code has been detected successfully , a file [avbarcode.ini] will be created and stored in the following path:

Windows XP: C:\Documents and Settings\All Users\Application Data\%PRODUCTNAME%

Vista, Windows 7, Windows 8, Windows 10: C:\ProgramData\%PRODUCTNAME%

Barcode Types:

The following barcode types can be detected.

Two-dimensional codes

- Aztec
- DataMatrix
- PDF417
- QR Code

One-dimensional barcodes:

- Add-2
- Add-5
- Australian Post 4-State
- BCD Matrix
- Codabar
- Code 128
- Code 32
- Code 39
- Code 93
- DataLogic 2 of 5
- EAN 128
- EAN-13
- EAN-8
- GS1 DataBar
- Industrial 2 of 5
- Intelligent Mail
- Interleaved 2 of 5
- Inverted 2 of 5
- IATA 2 of 5
- Matrix 2 of 5
- PostNet
- Royal Post 4-State
- UPC-A
- UPC-E

Barcode Zone:

Specify the barcode zone to be detected.

Select 「**All**」 to checks the whole document and detects barcodes. Or you may speed up the process by specifying a detection area since only the specified area is checked.

Choice: All, Top, Bottom, Left, Right, Bottom Right, Bottom Left, Top Right, Top Left

Choice for barcode zone on a page:

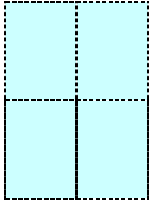
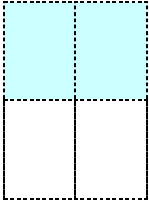
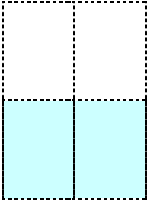
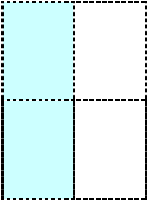
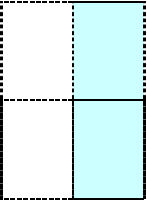
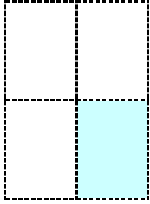
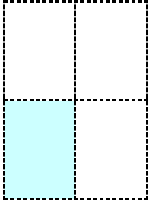
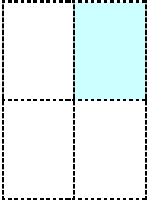
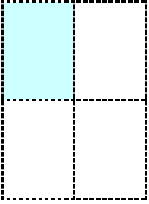
 All	 Top	 Bottom	 Left	 Right
 Bottom Right	 Bottom Left	 Top Right	 Top Left	

Note:

- Recommended resolution: 200~600 dpi for regular barcode, 300~600 dpi for QR code
- Skewed barcodes may not be recognized correctly.
- Using the same sheet repeatedly may decrease the recognition accuracy due to accumulated dirt on the sheets. If the sheet is not recognized correctly or gets smudged, replace it with a new sheet.

Patch code Detection:

Check [**Enable**] to detect patch codes and notify the software application for advanced processing.

A patch code is a pattern of parallel, alternating black bars and spaces (i.e. a barcode) that is printed on a document. Patch code sheet is most commonly used as a document separator in a stack of document.

You can find various sizes of patch codes (PDF) by choosing [**Start**] menu>[**All Programs**]>[**Avision Scanner Series**]>[**Patch code**] in succession.

Simply print the PDF file to produce the patch code sheet. Insert the patch code sheets to wherever you want the file to separate.



Patch code sheet

Notes to print the patch codes:

- Use blank white paper.
 - Set the scaling to 100%. The sheet is not recognized correctly when printed in a size smaller than the original.
 - Do not use toner saving mode. The sheet is not recognized correctly when the print is too light.
 - Do not use thin paper in order to avoid bleed-through from the back.
 - When you copy a patch code sheet that you printed out, make sure to copy by the same size and brightness as the original copy.
 - Use the same sheet repeatedly may decrease the recognition accuracy due to accumulated dirt on the sheets. If the sheet is not recognized correctly or gets smudged, replace it with a new sheet.
-

The Setting Tab

The Setting tab allows you to set the following settings:

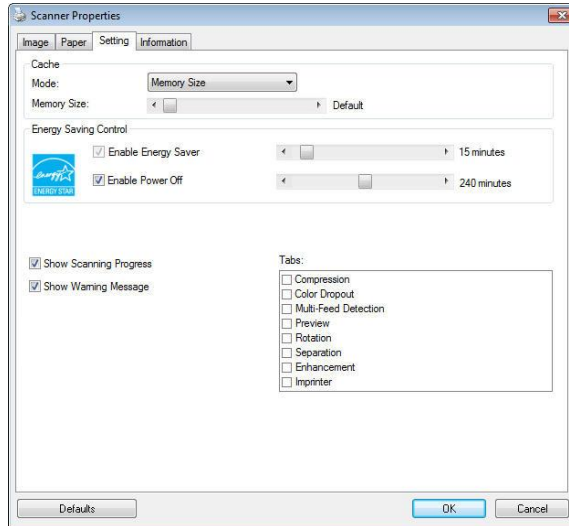

The Setting tab dialog box

Energy Saving Control	Check the Enable Energy Saver box and move the slider to set the amount of time to start the energy saver after your last action. The range is from 1 to 60 minutes.
Enable Power Off	Check the Enable Power Off box and move the slider to set the amount of time to automatically turn off the scanner after your last action. The range is from 1 to 480 minutes. The default is 240 minutes (4 hours). Note the value of "Power Off" has to be greater than or equal to the value of "Energy Saving".

<p>Cache</p>	<p>Mode: None, Page Number, Memory Size.</p> <p>This option allows you to assign a specified memory size from the available RAM to process the image data. By specifying a smaller memory size, you can free more memory for other applications you are running. By specifying a larger memory size, you can have more memory to process the image data especially when you have a large amount of documents needed to be scanned.</p> <p>You can also specify your memory size by the page number. For your information, an A4 color document scanning at 300 dpi consumes approximates 24MB.</p> <p>Image Count</p> <p>When the selected cache mode is "none", the image count option allows you to assign number of pages you need to scan. For example, if you wish to scan the first two pages, simply move the page slider to 2, and the scan action will be stopped when the scanning of the first two pages have been completed.</p>
<p>Show Scanning Progress</p>	<p>Check and the scanning progress bar will be shown during scanning.</p>
<p>Show Warning Message</p>	<p>Check to show the warning messages such as "ADF pad count exceeds 50,000 scans (the number varies based on type of scanner). Please replace the ADF pad and reset the pad count."</p>
<p>Save Settings after Closing</p>	<p>Check to save your scanner properties settings after leaving the dialog box. Next time when you open the Scanner Properties dialog box, the previously saved settings will be shown.</p>

The Imprinter Tab

The Imprinter tab allows you to print alphanumeric characters, date, time, document count and custom message on your scanned image if digital imprinter is selected or at the back of your document if external imprinter is selected.

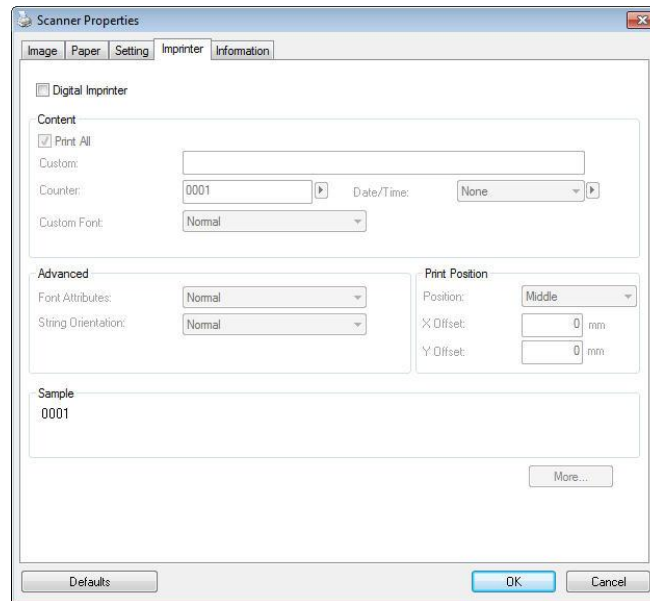

Choice: External Imprinter, Digital Imprinter. If you have installed an external imprinter, choose external imprinter. If you do not have an imprinter, choose digital imprinter. Note External Imprinter provides a vertical and rear-side print capability while digital printer provides a horizontal and front-side print capability.

Contents

Print All	Check Print All to automatically print the text at all pages of your documents. Uncheck Print All to print the text for the first page of your documents only.
Custom	Enter your custom text to be included in your print string.
Counter	Show the document count for the scan session. This value is increased sequentially by the scanner.
Date/Time	Choose if you wish to include the date and time in your print string. Format: YYYYMMDDHHSS For example, 20090402170645-check0001 indicates year, month, date, hour, seconds, your custom text and the counter.
Custom Font	Choose your desired font. Choice: Normal, Fixed Width Fixed Width (Mono spaced) fonts have a fixed character spacing. So each character occupies the same width.

Advanced

<p>Font Attributes</p>	<p>Choose your font attributes. Choice: Normal, Underline, Double, and Bold.</p>								
<p>String Orientation</p>	<p>Choose your string orientation. Choice: Normal, Rotated, Vertical, Vertical Inversion, 90 degrees CW, 90 degrees CCW</p> <table border="1" data-bbox="600 490 1201 1341"> <tr> <td data-bbox="600 490 900 734"> <p>2010abc</p> <p>Normal</p> </td> <td data-bbox="900 490 1201 734"> <p>2010abc</p> <p>Rotated</p> </td> </tr> <tr> <td data-bbox="600 734 900 1061"> <p>2010abc</p> <p>Vertical</p> </td> <td data-bbox="900 734 1201 1061"> <p>2010abc</p> <p>Vertical Inversion</p> </td> </tr> <tr> <td data-bbox="600 1061 900 1341"> <p>2010abc</p> <p>90 degrees CW</p> </td> <td data-bbox="900 1061 1201 1341"> <p>2010abc</p> <p>90 degrees CCW</p> </td> </tr> </table> <p>If you check the digital imprinter to stamp text on your scanned image, the illustration of normal and rotated string is shown below:</p> <table border="1" data-bbox="600 1532 1201 1666"> <tr> <td data-bbox="600 1532 900 1666"> <p>2010abc</p> <p>Normal</p> </td> <td data-bbox="900 1532 1201 1666"> <p>2010abc</p> <p>Rotated</p> </td> </tr> </table>	<p>2010abc</p> <p>Normal</p>	<p>2010abc</p> <p>Rotated</p>	<p>2010abc</p> <p>Vertical</p>	<p>2010abc</p> <p>Vertical Inversion</p>	<p>2010abc</p> <p>90 degrees CW</p>	<p>2010abc</p> <p>90 degrees CCW</p>	<p>2010abc</p> <p>Normal</p>	<p>2010abc</p> <p>Rotated</p>
<p>2010abc</p> <p>Normal</p>	<p>2010abc</p> <p>Rotated</p>								
<p>2010abc</p> <p>Vertical</p>	<p>2010abc</p> <p>Vertical Inversion</p>								
<p>2010abc</p> <p>90 degrees CW</p>	<p>2010abc</p> <p>90 degrees CCW</p>								
<p>2010abc</p> <p>Normal</p>	<p>2010abc</p> <p>Rotated</p>								

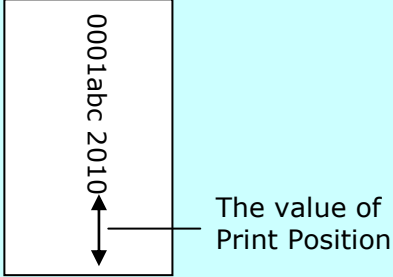
<p>Print Position</p>	<p>Choose the position you wish to print your string. Move the slider to the right to increase the value or to the left to decrease the value. Range: 0~355mm, default:0 mm</p> <p>The value indicates the height from the bottom of your paper to the last letter of your string. This option is available only if an external imprinter is installed.</p> <div data-bbox="815 607 1209 882" style="text-align: center;">  <p>The value of Print Position</p> </div>
------------------------------	--

Print Position (for digital imprinter)

Choose the position of your printed string. **Choice: Top, Middle, Bottom, Custom.** If Custom is selected, enter the X and Y offset value to specify the position.

The Information Tab

The Information tab displays the following system and scanner information.

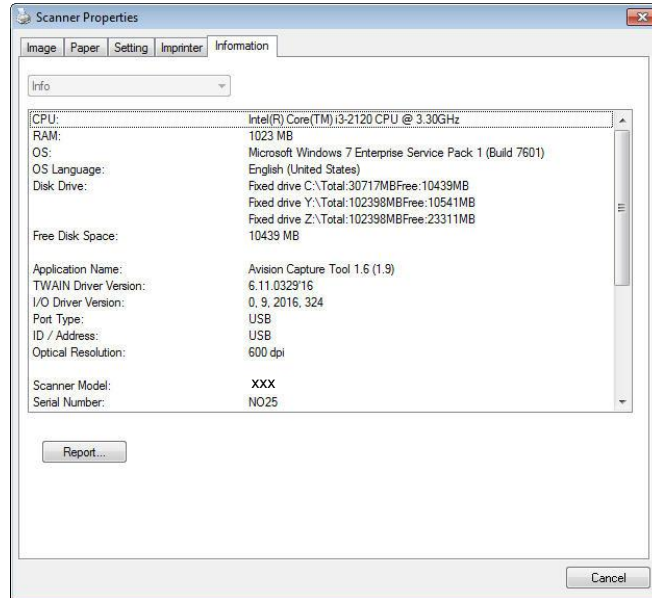

The Information tab dialog box

The "Report" button :

If you encounter any error message while using the scanner, click the Report button. A report.txt file [Windows XP: C:\Documents and Settings\All Users\Application Data\%PRODUCTNAME%; Vista, Windows 7, Windows 8, Windows 10: C:\ProgramData\%PRODUCTNAME% (C: system drive)] will be generated. Please send this file to the nearest service center for trouble shooting.

The "Reset Roller Count" button :

After scanning over a recommended number of pages (refer to subsequent section 7.4 Replacing the ADF Roller) through the ADF, the ADF roller may be worn out and you may experience problems with document feeding. In this case, it is highly recommended to replace the ADF roller with a new one. (Note the replacement of the ADF roller has to be performed only by authorized service center. Therefore, please return your scanner for roller replacement.) After replacing the ADF roller, click the "**Reset Roller Count**" button to reset the roller count.

Note :

The lifetime and the replacing procedure vary based on type of scanner.

9 ISIS Interface Operation

* Please refer to the preceding chapter, Scanner Installation, to install ISIS scanner driver. You may start your ISIS-compliant software application to scan via the ISIS user interface. The ISIS driver operation method is similar to the TWAIN's. Every function on the ISIS interface screen is briefly described as below:

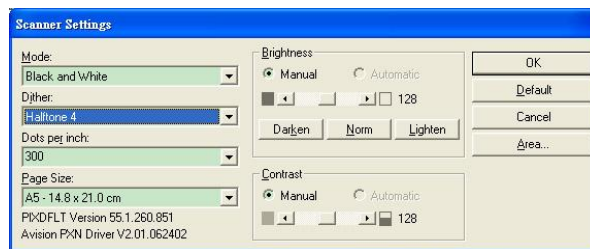

Mode: Select one of scan modes, including B&W, gray, color options.

Dither: 5 halftone levels available, can be disabled.

Dots per inch: Select your desired resolution.

Paper Size: Select your desired paper size.

Brightness: Adjust your scan image brightness or darkness.

Contrast: Adjust the range between the darkest and the lightest shades in the image.

Default: Click to reset all settings.

Area: Select your desired scan area or position.

10 Scanning and Sending the Scanned Images to Your Computer (BM2 Air)

Before You Begin:

Before you begin using the function of [BM2 Air], please make sure you have already installed the scanner driver, Button Manager V2, and connecting to the scanner to your computer via a USB cable or an ethernet cable as described in the preceding section, chapter 7 Using the Product as a Regular Scanner.

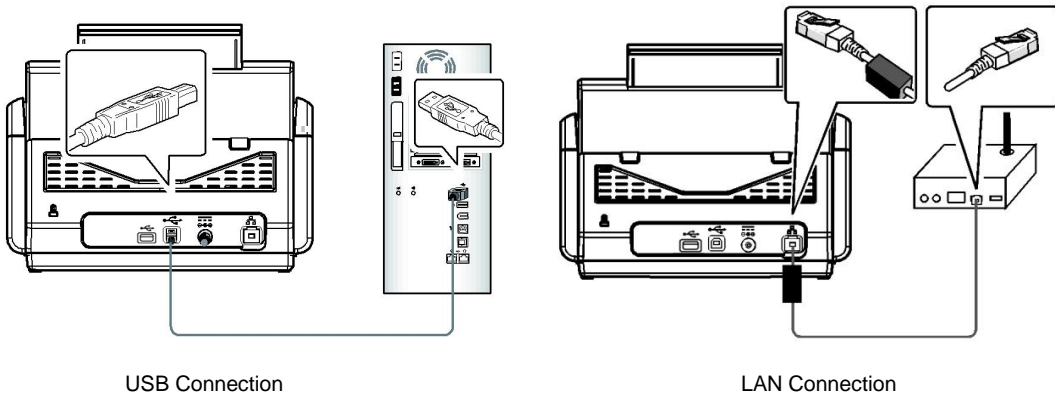

Installing Button Manager V2

Button Manager V2 provides you an easy way to scan your document and then link the scanned image to your designated software application. All this can be done by a simple touch of the button on the scanner. Yet, before you scan, it is recommended to check the button configurations first to ensure a proper file format and a destination application.

Checking the Button Configurations before Scanning

1. Button Manager V2 runs from the system tray. After Button Manager V2 and the scanner driver are properly installed, Button Manager V2 is started and the Button icon will be displayed on the system tray at the bottom right corner of your computer screen.



2. Left-click the Button Manager V2 icon to prompt the following Button Panel.

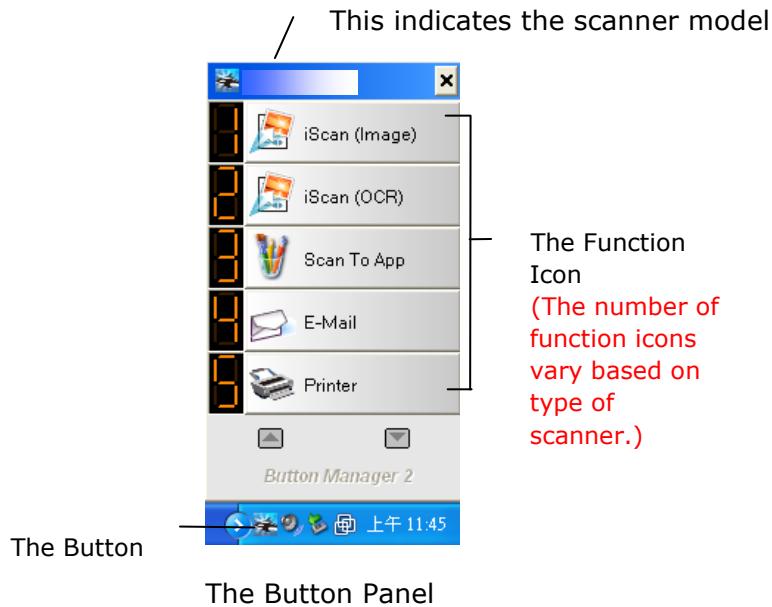

- The Button Panel shows the first five scanning buttons. Right-click the button (function) you wish to check. The Button Properties window appears.

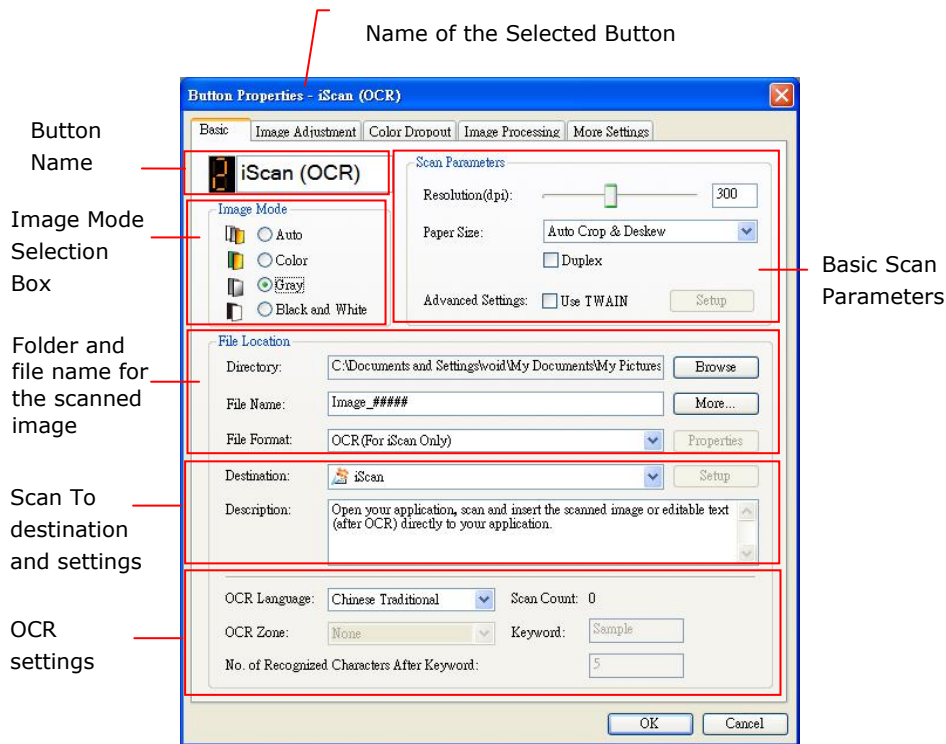

If you wish to change the setting, use this window to reset the setting for the file format, destination application, or other scan settings.

- Click the OK button to leave the window.

Scanning From One Touch of the Buttons

1. Adjust the paper guide for the width of paper and load the document with their tops into the automatic document feeder.
2. Use ▼ to scroll down to [BM2 Air] on the LCD display.
3. Check the button (function) number on the LCD screen to ensure if you are selecting the proper scan settings and destination application. (For example, if you wish to scan with button (function) 3, "Scan to App", which opens Microsoft Paint and displays the scanned image in the window of Microsoft Paint, the LCD screen should show "Function 3").
4. Press the **Scan** button on the scanner.
5. After the scanning is finished, the Microsoft Paint software will be launched and the scanned image appears in the main window of Microsoft Paint as below.

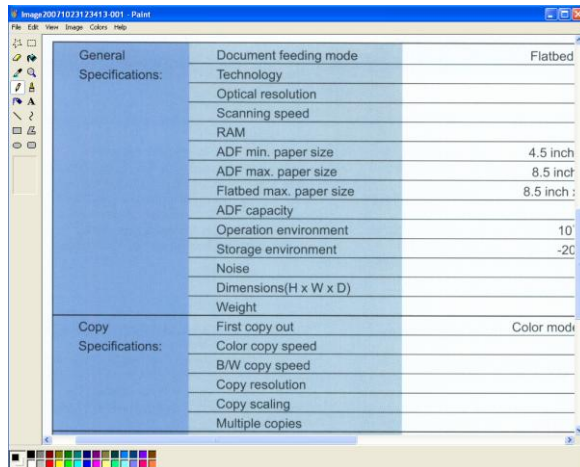

Note:

1. For details information on how to use the Button Manager V2, please refer to the user's manual in the supplied CD.
 2. You may also use Button Manager V2 on your desktop by starting Button Manager V2 from All Programs or double clicking the Avison Scanner Utility from the Control Panel.
-

11 Troubleshooting

Clearing Paper Jams

In the event of a paper jam, follow the procedures below to remove the paper:

1. Press the ADF Release Button on the right side. Gently open the Scanner Front Door to the left.
2. Carefully pull the paper out of the ADF unit.

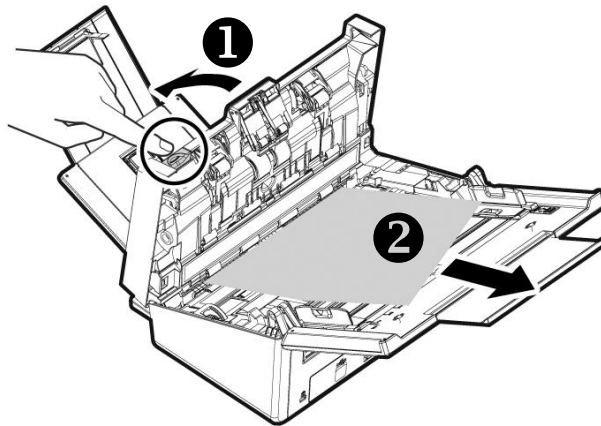

3. Close the scanner front door. Your Scanner is now ready to use.

Questions and Answers

Question:	Paper becomes jammed during scanning.
Answer:	<ol style="list-style-type: none">1. Open the front door.2. Pull out the jammed paper carefully.3. Close the front door.

Question:	More than one sheet of paper are fed into the scanner.
Answer:	<ol style="list-style-type: none">1. Open the scanner front door.2. Remove the multi-fed sheets.3. Close the front door.4. Flatten the corners and edges. Loosen the paper before putting it into the paper guide again.5. Check the feeding roller condition. If necessary, follow the cleaning directions and perform the cleaning.

Question:	Paper becomes skewed in the scanner.
Answer:	<ol style="list-style-type: none">1. Use the slide guide to keep the paper path straight.2. Check the condition of the feeding roller. If necessary, follow the cleaning directions and perform the cleaning.

Question:	Why does my scanned image always come out too dark?
Answer:	<ol style="list-style-type: none">1. Please adjust the screen settings to SRGB.2. Please adjust the brightness settings on the screen from application software.

Errors Indicated on the Touch Screen

Error Code and Error Messages

Error code	Problem Description	Solution
Network Errors		
592301	Mail server is not set.	1.Check "Mail server" setting. 2.Contact your your network administrator for further help.
592302	DNS server is not set.	1.Check "DNS server" setting. 2.Contact your network administrator for further help
592303	Failed to convert Computer Name to IP.	1.Check "DNS server" setting 2.Check target server name and domain in CIFS URL. 3.Check Client for Microsoft Networks on PC side. 4.Contact your network administrator for further help
592304	Failed to get IP address from DNS server.	1.Check "DNS server" setting 2.Check target server name. 3.Contact your network administrator for further help.
592305	Detected an IP address conflict.	1. Check network settings. 2. Contact your network administrator for further help.
NTP Errors		
593001	NTP server does not respond within the timeout period.	1.Check "NTP server" setting. 2.Check firewall settings. 3.Check network environment. 4.Contact your network administrator for further help

LDAP Errors		
596001	LDAP URL is empty.	Enter LDAP server IP or Port.
596002	Failed to connect to LDAP server.	Check LDAP server IP or Port.
596003	Authentication type error.	Check the authentication type.
596004	LDAP account or password is empty.	Enter login name and password.
596005	Please check login name and password.	Check login name and password.
596006	Search root is empty.	Enter "search root".
596007	Failed to search.	Check "search root".
596008	Search attribute is empty.	Enter "search attribute".
Wi-Fi Errors		
597001	Failed to connect to Wi-Fi AP.	Check password if Wi-Fi AP (Access Point) requires password.
597002	Failed to initiate AP scan.	Scanner fails to scan in AP mode. Try later. If this problem always exists, contact your nearest dealer.
597003	Unable to find a wireless AP.	Scanner does not search any Wi-Fi AP. Try again later. If this problem always exists, contact your nearest dealer.

SMTP Errors		
530002	Failed to connect to Mail server.	<ol style="list-style-type: none"> 1. Check Mail server address and port number. 2. Check network environment. 3. Contact your network administrator for further help
530003	Failed to connect to Mail server via SSL.	Contact your network administrator about Mail server settings. Set correct Authentication method and Encrypt.
530004	Failed to connect to Mail server because server requires SSL connection.	<ol style="list-style-type: none"> 1. Contact your network administrator about Mail server settings. 2. Set correct authentication method and encrypt. 3. Change encrypt setting to SSL and try again.
531011	Mail server requires TLS/STARTTLS connection.	<ol style="list-style-type: none"> 1. Contact your network administrator about Mail server settings. 2. Set correct authentication method and encrypt. 3. Change encrypt setting to TLS/STARTTLS and try again.
531012	Scanner tries to do authentication, but mail server does not require it.	<ol style="list-style-type: none"> 1. Contact your network administrator about Mail server settings. 2. Set correct authentication method. 3. Change authentication method to None and try again.
531013	Authentication method replied by Mail server is not supported on this scanner.	Contact your network administrator.
538001	Connection is broken during data transmission.	<ol style="list-style-type: none"> 1. Check network environment. 2. Check if email attachment size is larger than the mailbox quota.

530421 531421 532421 533421 534421 536421	Mail server replies that service is not available.	Contact your network administrator for further help.
537550	Login name must be the same as From address.	The account of from and login must be same
533450	Recipient mailbox may be not available.	Check "To" addresses.
532451 533451 534451 535451 537451	Requested action is aborted by Mail server.	Contact your network administrator for further help.
533452 535452 537452	One recipient's mailbox has insufficient storage.	1.Check recipient mailbox quota. 2.Contact your network administrator for further help.
530500	Failed to connect to Mail server via TLS/STARTTLS.	1.Contact your network administrator about Mail server settings. 2.Set correct authentication method and encrypt. 3.Change encrypt setting to None and try again.
532530	Mail server requires to do authentication.	Contact your network administrator about Mail server settings, authentication method and encrypt setting.

531534	Mail server rejects your login.	<p>1.If you are using Gmail as mail server, please turn on "Access for less secure apps". Or enabling 2-Step Verification and then create an "app password" for scanner.</p> <p>2.If you are using Gmail as mail server, you can login on A place, at the same time, someone uses your account to login on B place. Gmail will reject someone's login.</p> <p>3. Please contact the administrator of mail server.</p>
531535	Failed to login to Mail server.	<p>1.Server requires authentication.</p> <p>2.Check login name and password.</p>
533001	To, CC and BCC addresses are empty.	Enter email address.
533550	Recipient mailbox may be not available.	<p>1. Check recipient's addresses.</p> <p>2. If mail server is Microsoft Exchange, please check the settings on mail server, is the IP of machine allowed to send mail?</p>
535552 537552	Mail attachment size exceeds Mail server's limitation.	1. Check mailbox storage allocation.
533553	Recipient address is not correct.	Check "To" addresses.
532440 532553 532554 537554	From address is not correct.	Check "From" address.
532501	From address is invalid.	Check "From" address.
533504	HELO command is rejected.	Check "Host Name" and "domain name".

FTP Errors		
540002	Failed to connect to FTP server.	Make sure the FTP server has not been shut down and port number is correct. If firewall is enabled, check firewall settings.
540003	Failed to connect to FTP server via SSL.	Make sure the FTP server has not been shut down and port number is correct. If the error is still there, contact your your network administrator or FTP server administrator.
540004	Failed to login to FTP server.	Check your login name and try again.
540005	Failed to login to FTP server.	Check your password and try again.
540020 540021	FTP control connection is broken.	<ol style="list-style-type: none"> 1. Contact your network administrator to check FTP server log. 2. Contact your network administrator to check network environment.
540023	FTP server does not open data connection to scanner.	<ol style="list-style-type: none"> 1. Contact your network administrator to check firewall settings. 2. Contact server administrator to check ftp server log. 3. Change Active mode to Passive mode and try again.
546005	Data connection is broken during transmission.	<ol style="list-style-type: none"> 1. Contact server administrator to check server log. 2. Check network environment.
549002	Failed to open passive mode data connection to FTP server.	<ol style="list-style-type: none"> 1. Contact your network administrator to check firewall settings. 2. Contact your network administrator to check FTP server log.
540421	FTP server replies that service is not available and it closes control connection.	<ol style="list-style-type: none"> 1. Too many connections from this IP, contact your FTP server administrator. 2. FTP server shut down and cannot provide services. 3. Try again later. If problem persists, contact FTP server administrator.

546425	Failed to open data connection to FTP server.	Contact your network administrator to check firewall settings and FTP server log.
544450 546450 548450	Failed to access file because it's locked on server.	The file already exists and is locked by Windows. Check your network administrator.
546452 548452	Insufficient storage space in FTP server.	Ask server administrator to increase allocated storage space, or delete unnecessary files.
540550	Failed to access target directory or directory has been deleted.	1. Check if the directory exists or not. 2. Check if the directory is empty or not.
541550 542550 546550	Failed to write file to FTP server.	1. Confirm that you are attempting to connect to the correct server/location. 2. The administrator of the remote server must provide you with permissions to access files via FTP. 3. Check if file has not been opened.
543421	Server does not support active mode.	Please enable "passive mode" and try again.
546553 548553	Filename is not allowed on FTP server. Please check filename.	Change the file name or delete spaces/special characters in the file name.
CIFS Errors		
560029	Account is locked. Please contact your network administrator.	Contact your network administrator for further help.
560033	Failed to login to target PC.	Check domain in Network settings.
560034	The trust relationship between this workstation and the primary domain failed	Contact your network administrator for further help.
561003	Target PC's IP address is not correct.	1. Check the network cable or connector. 2. Check if URL or IP address is correct. 3. Check if "File and Printer Sharing for Microsoft Networks" is enabled.

561005	Access is denied from target PC.	Please check access permissions of shared folder on target PC.
561006	File is closed during communications.	Please check target PC.
561032	Sharing violation or file is in use on target PC.	Please check if shared folder name is correct.
562005	Shared folder does not exist during transmission.	Please check target PC.
562006	Shared folder name is not correct.	Please check profile settings and shared folder name on target PC.
562088	Target PC does not respond within the timeout period.	Server busy, and try scan-to CIFS again later.
563021	Target PC replies service is not ready.	1. Please wait CIFS service initialization, and try scan-to CIFS again later. 2. Please check the same hostname on different machines.
563039	Insufficient disk space on target PC.	Please clean up disk space.
569001	Connection is broken during communication.	Check the network cable or connector. Check if URL or IP address is correct.
569033	Shared path is not correct. No shared folder in the URL.	Please check if URL or IP address is correct.
569020	Target PC does not respond within the timeout period.	Server busy. Please try scan-to CIFS again later.

SharePoint Errors		
555400	Server error Request parameter error.	Please check if the login information such as user name, password, server IP, Domain, location URL, or subfolder is correct and check also the network connection status.
555401	Server error : Login failed.	Please check if the login information such as user name, password, server IP, Domain, or location URL is correct and check also the network connection status.
555402	Attachment exceeds limitation.	Please inform the server administrator to change the max. upload file size. And please check the settings with your server administrator.
HTTP Errors		
550002	Failed to receive data.	Check network environment.
550004	Data length is wrong.	Please try again.
556001	HTTP server URL is invalid.	Check the format of URL.
556002	Failed to connect to HTTP server.	1. Check the server name or IP in URL 2. Check network environment.
556003	Connection is broken and failed to send header to HTTP server.	1. Check the network cable or connector 2. Contact your network administrator for further help
556004	Connection is broken and failed to send data to HTTP server.	1. Check the network cable or connector 2. Contact your network administrator for further help
556005	Connection is broken and failed to receive data from HTTP server.	1. Check the network cable or connector 2. Contact your network administrator for further help
556006	The size of received data from HTTP server is wrong.	The size of received data is not equal to the content length. 1. Check the network cable or connector. 2. Contact your network administrator for further help.

AWIP Errors		
557001	Failed to connect to remote App.	Check network environment.
557002~ 557005	Failed to send file to remote App.	Check network cable and connector. Contact your network administrator for further help.
System Errors		
150001	Scanner not ready	Reboot your machine. If the problem persists, please call service personnel for help.
150004	Unauthorized network access, please login first	Please login first.
151004~ 151010	Failed to save scanned image file.	Please try again. If the problem persists, please call service personnel for help.
152004~ 152005	Scan parameter error.	
152006	Failed to allocate memory.	
152999 153001~ 153003	Internal error	
153005	Insufficient memory	
153010 153020~ 153026 153021	Internal error	Please restart the product and try again. If the error persist, please call service personnel for help.
153022	Scanner busy.	
153023~ 153026	Internal error	
170004	Internal error.	

170005	Send action is stopped	Please restart the product and try again. If the error persists, please call service personnel for help.
170011	Failed to send filing report to email.	Please check your SMTP settings or contact your network administrator.
171201 172202 173204	Internal error.	Please restart the product and try again. If the error persists, please call service personnel for help.
175101	Failed to save file into public folder.	
175102	Public folder disk space is not enough.	Contact your network administrator.
175201~ 175205	Failed to save file into public folder.	Restart the product and try again. If the error persists, please call service personnel for help.
176003	Internal error.	
177102	Public folder disk space is not enough.	Contact your network administrator.
178102 179204	Can not get IP.	
180001~ 180002	Internal error.	Please restart the product and try again. If the error persists, please call service personnel for help.
180010	Send action is stopped.	Please restart the product and try again. If the error persists, please call service personnel for help.
182001	Failed to create thumbnail image.	Please restart the product and try again. If the error persists, please call service personnel for help.
182002	Create thumbnail action is stopped.	Please restart the product and try again. If the error persist, please call service personnel for help.
183006 185201	Internal error.	Please restart the product and try again. If the error persists, please call service personnel for help.

BM2 and VSL Errors		
200100	To use the [BM2] function, you need to first install Button Manager V2 onto your computer.	Check if the PC has installed Button Manager.
200101	VSL disconnect.	Check if the VSL connection on the PC still work.
Scanner Errors		
000016	UART read and write test error	Restart the device. If the error persists, call service to replace the main board.
000017	Motor Stall	Restart the device. If the error persists, call service to replace the motor.
000020	Download firmware error	Check firmware file and try again.
000022	Lamp off error.	Restart the device. If the error persists, call service to replace the lamp.
000023	Flashrom read and write test error.	Restart the device. If the error persists, call service to replace the main board.
000029	ADF AFE read and write test error.	Restart the device. If the error persists, call service to replace the main board.
002013	Paperjam	Open the front door to remove the jammed paper.
002014	ADF cover opens	Close ADF cover.
002015	ADF no paper.	Load paper into the auto document feeder.
002024	NVRAM read and write test error.	Restart the device. If the error persists, call service to replace the main board.
003101	Multiple feed	Remove paper. Fan your paper and tray again.
002033	Page skew.	Remove paper. Fan your paper and try again.
002036	Ultrasonic sensor error	Restart the device. If the error persists, contact service personnel.
002037	ADF Bottom head AFE test error.	Restart the device. If the error persists, call service to replace the main board.
002040	Fan check error	Restart the device. If the error persists, contact service personnel.
003003	DRAM read and write test error.	Restart the device. If the error persists, call service to replace the main board.

003004	ADF DRAM read and write test error.	Restart the device. If the error persists, call service to replace the main board.
003006	ADF Bottom Head light check error.	Restart the device. If the error persists, call the service to replace the lamp.
003010	ADF Top Head light check error.	Restart the device. If the error persists, call the service to replace the lamp.
003211	Page miss-feed	Make sure the edge of your document slightly touch the paper guides and try again.

Technical Support

If your problem still exists after trying the above solution, please contact our technical support.

Headquarter

Avision Inc.

No. 20, Creation Road I, Science-Based Industrial Park,
Hsinchu 300, Taiwan, ROC

TEL: +886 (3) 578-2388

FAX: +886 (3) 577-7017

E-MAIL: service@avision.com.tw

Web Site: <http://www.avision.com.tw>

US and Canada Area

Avision Labs, Inc.

6815 Mowry Ave., Newark CA 94560, USA

TEL: +1 (510) 739-2369

FAX: +1 (510) 739-6060

E-MAIL: support@avision-labs.com

Web Site: <http://www.avision.com>

China Area

Technical Support Center in Shanghai

7A, No.1010, Kaixuan Road, Shanghai 200052 P.R.C.

TEL :+86-21-62816680

FAX :+86-21-62818856

E-MAIL: sales@avision.net.cn

Web Site: <http://www.avision.com.cn>

Europe Area

Avision Europe GmbH

Bischofstr. 101 D-47809 Krefeld Germany

TEL: +49-2151-56981-40

FAX: +49-2151-56981-42

E-MAIL: info@avision-europe.com

Web Site: <http://www.avision.de>

South American

Avision Brasil Ltda.

Rua Bamboré 41, Vila Monumento, Ipiranga. CEP: 04278-060, São Paulo, Brasil

TEL: +55-11-2737-2005

E-MAIL: suporte@avisionbrasil.com.br

Web Site: <http://www.avisionbrasil.com.br/>

12 Maintenance

Cleaning the Touch Screen

Wipe the Touch screen Monitor with a wet cloth first then wipe it with a dry cloth.

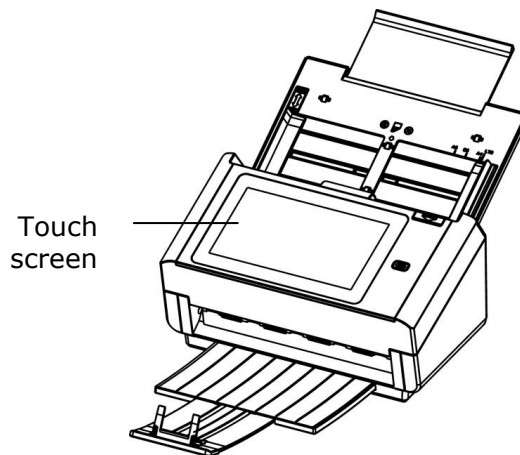

Warning:

Do not use liquids, household cleaners, or neutral detergents, as they may damage the touch screen.

Cleaning the ADF

After using the scanner for a long period of time, the rollers and glass inside the scanner may become contaminated with ink, toner particles or paper dust. It is necessary to perform routine cleaning to ensure the optimum image quality and performance. As a guideline, please clean the rollers and glass after first 4,000 to 5,000 scans and then perform the cleaning on a weekly basis. Note that the guideline varies according to the type of documents you are scanning.

Tip! If documents do not feed easily, if several documents feed at the same time or if streaks appear on the scanned images, it is time to clean your scanner.

The Cleaning Procedures

1. Soak a clean cloth with some isopropyl alcohol (95%).
2. Press the ADF Release button to open the front door to the left. Wipe and rotate the ADF Roller until the surface is completely removed from dust.

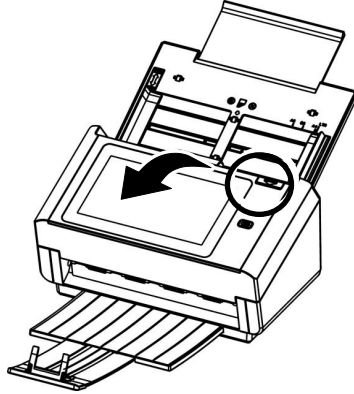

3. Wipe the rubber part of the ADF pad. Be careful not to damage the pick springs.
4. Close the scanner front cover. Your scanner is now ready for use.

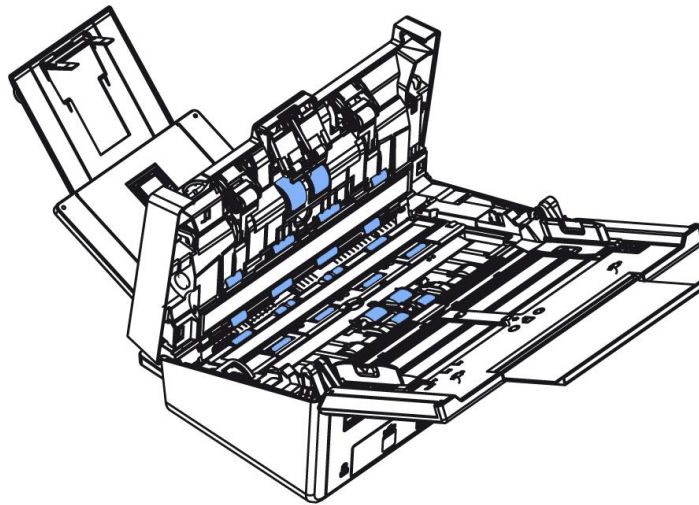

Cleaning the Glass

1. Press the ADF Release button. Open the front door to the left.
2. Wet a clean cloth with some isopropyl alcohol. (95%)
3. Wipe the glass and the white area as illustrated below to rid the dust or dirt.

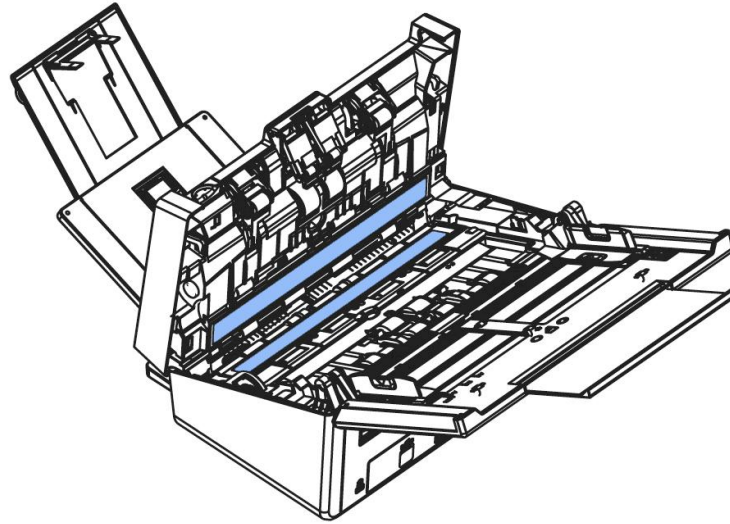

Cleaning the Ultrasonic Sensors

If the scanner sometimes fails to detect multi-feed via ultrasonic sensors, it is possible that paper dust or dirt may be accumulated on the surface of the ultrasonic sensors. Please follow these steps to clean the sensors.

1. Press the ADF release button. Open the front door.
2. Wet a clean cloth with some isopropyl alcohol. (95%)
3. Gently wipe the dirt and dust off the surface of the ultrasonic sensors.

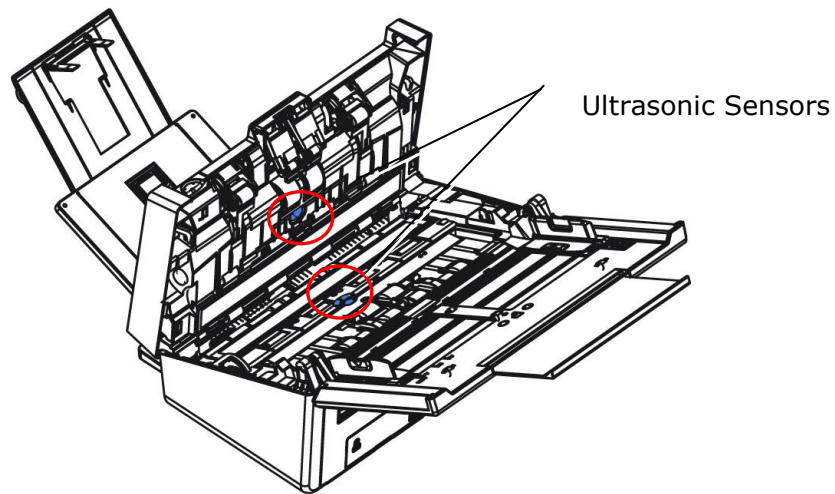

Note:

If it is difficult to clean, use a cotton swab.

The availability of ultrasonic sensor varies according to your scanner model.

Replacing the ADF Reverse Roller

After scanning approximately 100,000 pages through the ADF, the ADF Reverse Roller may be worn out and you may experience problems with document feeding. In this case, you may need to replace a new ADF reverse roller. For ordering the ADF roller, please consult your nearest dealer and follow the procedure below to replace it.

Disassembling Procedure

1. Press the ADF Release button.
2. Gently open the ADF Front Door to the left.
3. Hold the Reverse Roller Cover with your fingers as shown and place it down.

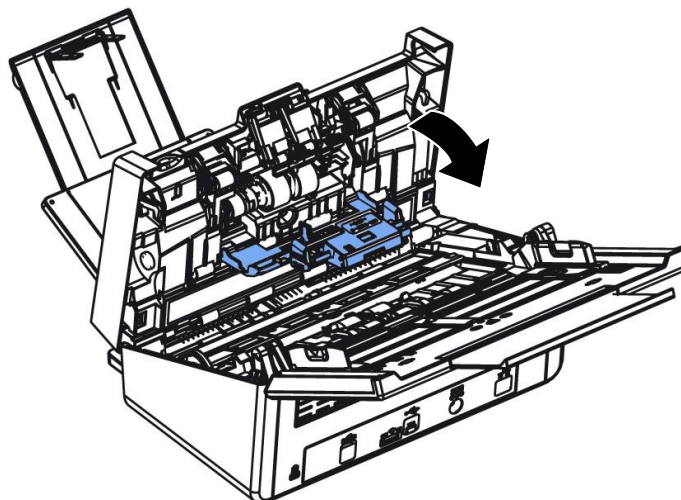
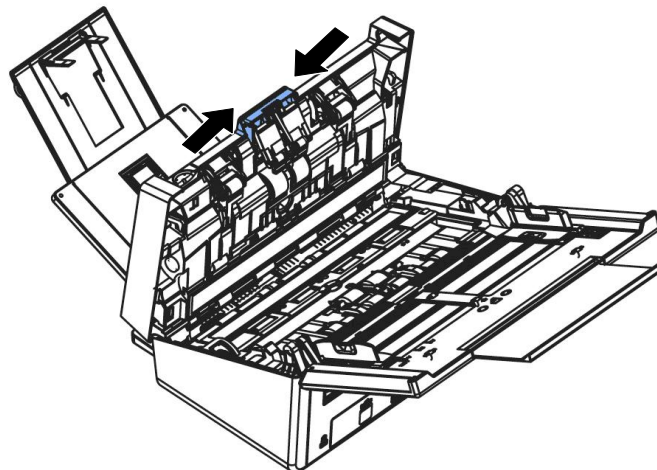

4. Press the right end of the Friction Roller externally to detach it from the slot and then detach the left end from its hole.

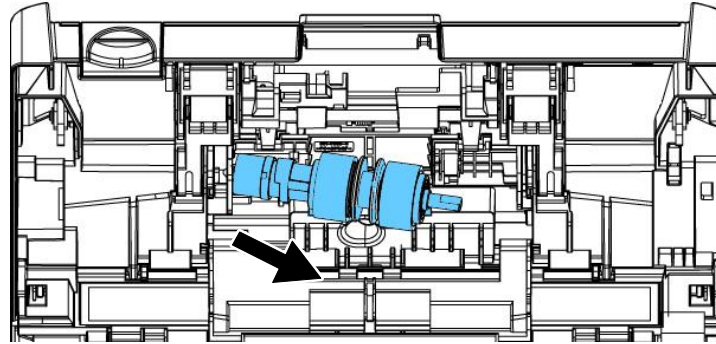

5. Remove rollers from the shaft.

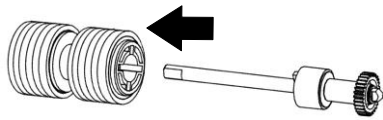

Reassembling Procedure

1. Insert the new rollers to the shaft.

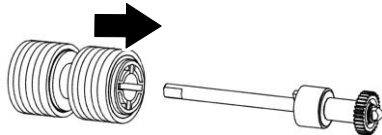

2. Grab the right end of the reverse roller (flat side facing Up) and insert it to its original place.

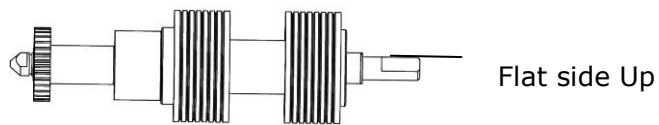

3. Insert the left end of the Reverse Roller to the hole of its original place.
4. Insert the right end of the Reverse Roller to its slot.

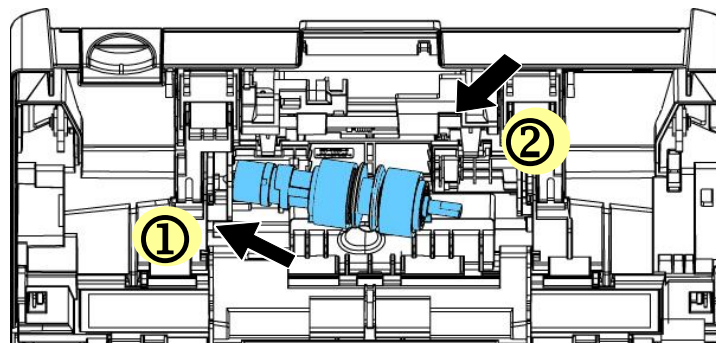

5. Close the Reverse Roller Cover.

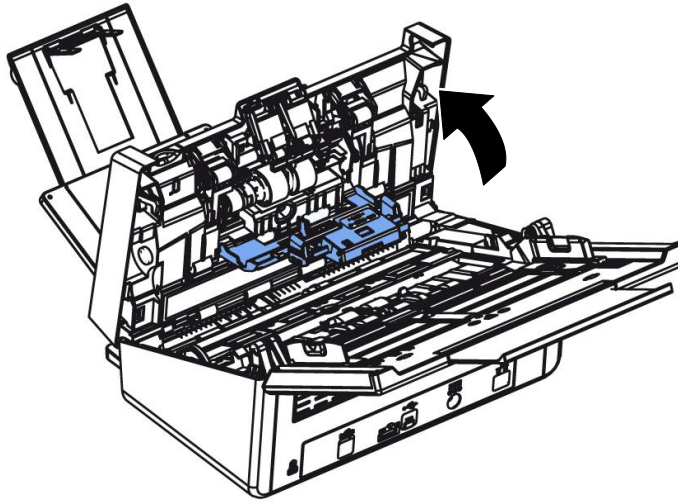

6. Close the ADF Front Cover.

Replacing the ADF Roller

After scanning approximately 200,000 pages through the ADF, the ADF rollers may be worn out and you may experience problems with document feeding. In this case, you may need to replace a new ADF roller. For ordering the ADF roller, please consult your nearest dealer and follow the procedure below to replace it.

Disassembling Procedure

1. Press the ADF release button to open the front door.
2. Pull the center of the roller cover to open it.

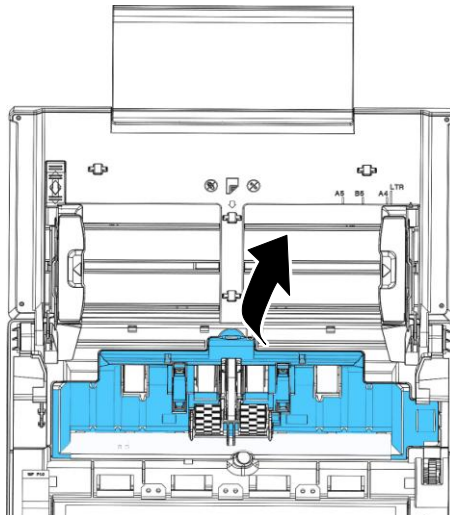

3. Move belt **UP** as indicated.

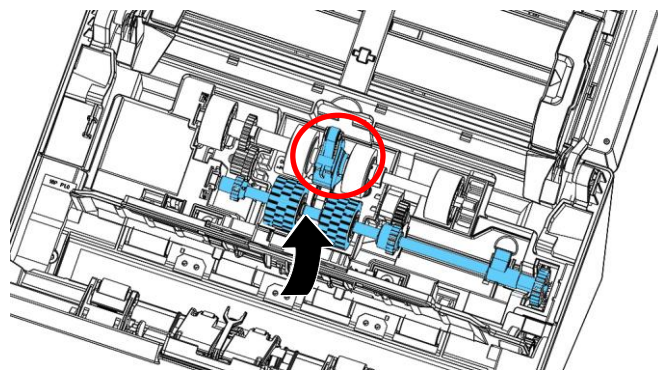

4. Move the tab of the ADF roller **DOWN** as indicated.

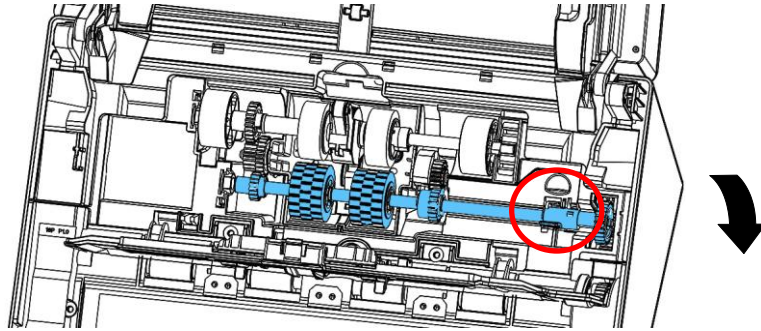

5. Detach the right end of the ADF roller from the scanner and remove the ADF roller.

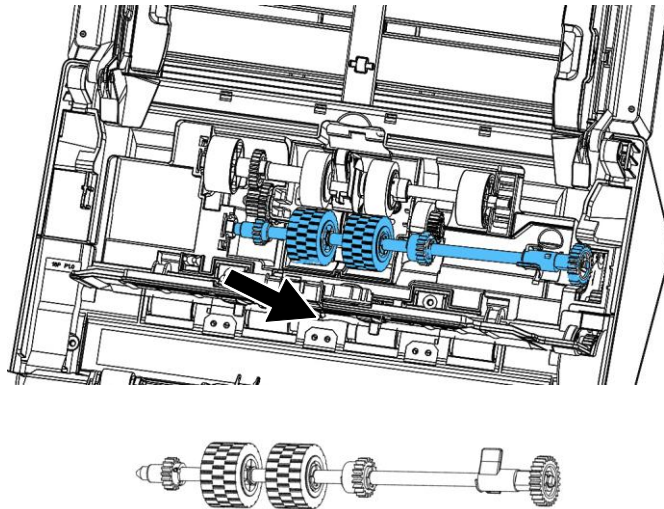

Assembling Procedure

1. Insert the left end of the ADF roller first to its slot and place the ADF roller to its proper position.

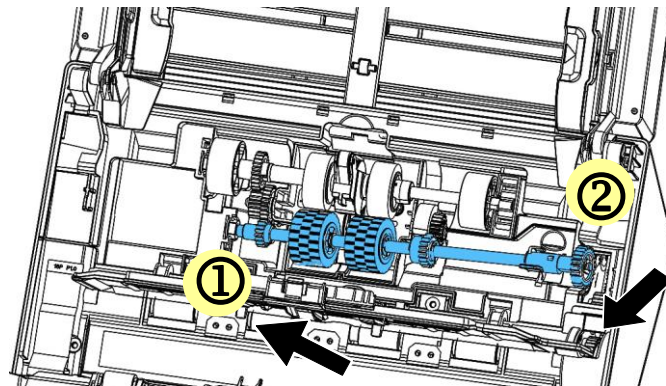

2. Move the tab of the ADF roller **UP**.

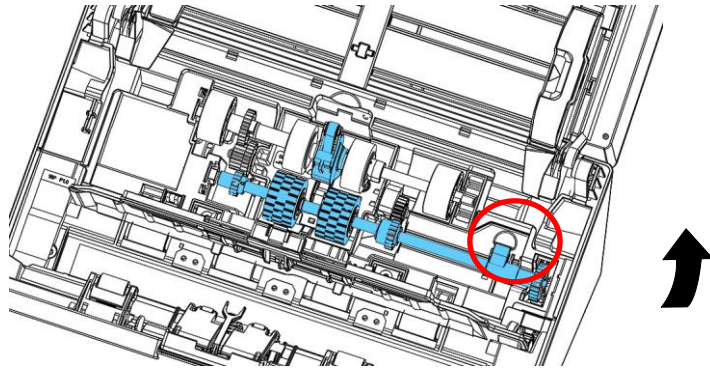

3. Pull the belt **DOWN**.

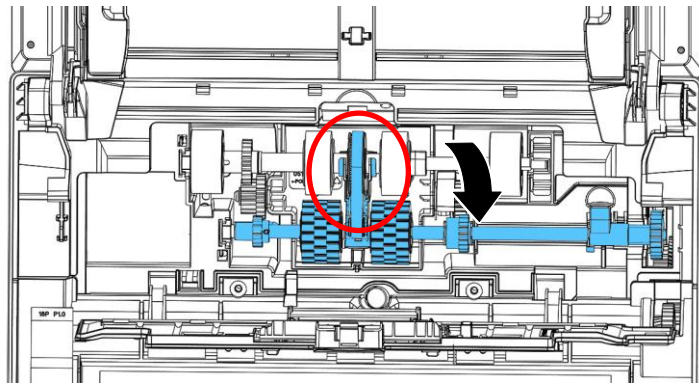

4. Close the ADF roller cover. A snap-in sound could be heard if correctly installed.

***Note:**

- Consumables must be replaced regularly. It is recommended to purchase new consumables in advance so that they can be replaced before the end of their life time.
 - The replacement cycle is based on the use of A4 (80 g/m² [20 lb]) wood-free paper or plain paper. The actual cycle varies according to the type of used paper and how frequently the scanner is used and cleaned.
 - Use only the specified consumables.
 - To purchase consumables, contact the store where you purchased the scanner or an authorized scanner service provider.
-

13 Specifications

All specifications are subject to change without notice. For more detailed information, please refer to our web site at www.avision.com

Items	Specifications
Model Number : FL-1801H	
General Specifications	
System Description	Network Scanner
Image Sensor	Contact Image Sensor (CIS)
Light Source	LED Light Bar
Optical Resolution	600 x 600 dpi
Output Resolution	1200 dpi (PC Scan)
Output Quality	Input: 48 bits color Output: 24 bits Color 8 bits Gray 1 bit Monochrome
LCD Size	8 inches
External Connections	1. RJ-45 (for Network connection) 2. USB 3.2 GEN 1X1
Network Connection	RJ-45 Ethernet 10/100/1000 Mb, Wi-Fi
Output Format	JPEG, TIFF (One-Page TIFF), M-TIFF (Multi-Page TIFF), PDF (One-Page PDF), *M-PDF (Multi-Page PDF), Searchable PDF, PDF/A(M-PDF), PNG
Dimension (WxDxH)	
Min.	316 x 207 x 178 mm (12.44 x 8.15 x 7.01 in.)
Max.	316 x 675 x 254 mm (12.44 x 26.57 x 10 in.)
Weight	4.2 Kg (9.26 lb)
Power Requirement	100~240Vac, 50/60Hz
Power Source	24Vdc, 2.0A
Operating Environment	Temperature 10°C~35°C
	Humidity 10%~85% RH
Scan Size	
ADF Paper Capacity	100 sheets (70 g/m ² or 20 lb. Paper)
ADF Paper Size	50 x 50 mm (2 x 2 in.) ~ 216 x 356 mm (8.5 x 14 in.)
Paper Thickness	27 ~ 413 g/m ² (7~110 lbs)

Network Specification	
Connectivity	RJ-45 Ethernet 10/100/1000 Mb, Wi-Fi
Communication Protocol	IPv4, TCP, UDP, DHCP, SSL/TLS, DNS, DDNS, SMTP, LDAP, LDAPS, SMTP, SMTPS, HTTP, HTTPS, MIME, FTP, FTPS, SMB, Ipsec, 802.1x
Configuration Requirement	<ol style="list-style-type: none"> 1. IP address 2. Subnet mask 3. Gateway 4. SMTP server 5. FTP server
E-mail Specification	
Communication Protocol	SMTP
File Formats B&W	PDF, TIFF, MTIFF
Gray/Color	PDF, TIFF, MTIFF, JPEG
Default File Format	PDF
Separation Limit	1MB, 3MB, 5MB, 10MB, 30MB, Unlimited
Resolution	100 dpi, 150 dpi, *200 dpi, 300 dpi, 400 dpi, 600 dpi
Default Resolution	200 dpi
Supported Mail Server Application	Lotus Mail Server 5.0 MS Exchange Server 2000 RedHat 7.0 SendMail MAC Mail Server in OS 9.04
Filing Specification	
Communication Protocol	FTP, FTPS, FTPES, SMB, SharePoint
File Formats	JPEG, TIFF (One-Page TIFF), M-TIFF (Multi-Page TIFF), PDF (One-Page PDF), *M-PDF (Multi-Page PDF), Searchable PDF, PDF/A(M-PDF), PNG
Resolution	100 dpi, 150 dpi, *200 dpi, 300 dpi, 400 dpi, 600 dpi
Max. Number of Filing Profiles	50

Wi-Fi Specifications:

Standard	IEEE 802.11 b/g/n standards compliant
Wireless LAN	1T1R Mode
Frequency Range	2.412 ~ 2.484GHz (subject to local regulations)
Modulation Type	CCK, DQPSK, DBPSK for DSSS 64QAM, 16QAM, QPSK, BPSK for OFDM
Modulation Technology	DSSS, OFDM
Transfer Rate	802.11b: up to 11Mbps 802.11g: up to 54Mbps 802.11n: up to 72.2Mbps
Output Power	802.11b: 149.279mW 802.11g: 360.579mW 802.11n (HT20): 345.939mW
Antenna	PCB antenna
Security	WEP 64/128, TKIP, WPA, WPA2 mixed, 802.1x and 802.11i